

MERLYN™
series

it's all about the experience



MERLYN™ | BLACK



See our new

**MERLYN BLACK
DOUBLE ENTRY, SQUARED
SHOWER PANEL.**

www.merlynshowering.com

MERLYN[™]
series



Contents

about.

Welcome to MERLYN	1
MERLYN Customer Service	2
The Series Collection	3
Mersfield Stayclear™ and Guarantee	7
revo rail - <i>Our safety rail & storage system</i>	8

products.

10 Series	13
Bespoke	23
8 Series Frameless	25
8 Series	39
6 Series Frameless	51
6 Series	55
Wetroom Panels	63
SecureSeal Bath Screens	73
Bath Screens	75
TrueStone Trays	85
Level25 Trays - <i>Slip Resistant tray</i>	87
MStone Trays	89

technical information.

Product Information	91
---------------------	----





welcome to MERLYN

We've built our name and reputation on a simple ethos – to deliver on everything we promise to our customers.

This is because you are at the heart of everything we do. We have a relentless desire to deliver the highest level of attention to detail.

Our award-winning customer service department – and the wider MERLYN team live this ethos every single day.

We're passionate about innovation, quality and design, and this is reflected throughout our ranges. Our unique approach has resulted in us becoming the No.1 shower enclosure brand in the UK and Ireland. When you choose a MERLYN shower you are investing in one of the world's most luxurious showering environments and you get the added peace of mind of our Lifetime Guarantee.

Thank you for choosing MERLYN.

The **MERLYN** Team



Award-Winning Customer Service

It is not about what we do but what we can do for you. We promise we will always be there for you at any stage of your journey with MERLYN. We have a genuine commitment to service and to finding a solution for you. Our specialised team's philosophy is to make everything easy for you and we will respond immediately to any request you might have.

We strive everyday to make excellence a habit. Contact our award winning dedicated team of specialists, who are on hand to give you a personalised solution to your query.

UK Freephone Number 0808 101 1429 | WhatsApp 00353 86 010002 | Online: sales@merlyn.ie

the series collection

It's all about the experience

Made up of shower enclosures, trays and bath screens, the MERLYN Series Collection is all about providing the ultimate showering experience – from the smooth running of the shower doors to the beautiful and elegant design and the quality of fittings.

6 | series

Affordable Quality



A beautifully styled product range with smooth and soft rolling action.

- Height 1900mm
- 6mm Glass Thickness

6 | series

frameless

Exceptional Value



Elegant and frameless designer range with beautifully crafted, unique one-piece hinges.

- Height 2000mm
- 6mm and 8mm Glass Thickness

8 | series

Style & Functionality



This product range is all about the feeling. With robust rolling action and a beautifully crafted sleek framed style.

- Height 1950mm
- 8mm Glass Thickness

10 | series

Exquisite design



Exquisite, towering 10mm product range. Balance of beauty and movement giving the user a sense of pure luxury.

- Height up to 2100mm
- 10mm Glass Thickness

revo

A steadying hand for all the family



revo answers your call for a sleek storage and safety system addressing the real needs of a growing and changing family today.



15 YEARS GUARANTEE



FOR ALL AGES



EASY CLEAN



150KG

8 | series

frameless

Elegantly minimalist



Considered the most beautiful frameless 8mm product range. With stunning design symmetry of unique one-piece hinge and towel rail handle, offering maximum access.

- Height up to 2000mm
- 8mm Glass Thickness

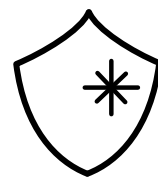

MERSHIELD™
STAYCLEAR

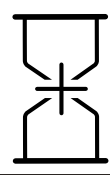

LIFETIME
GUARANTEE

MERLYN trays

The MERLYN tray collection offers a broad range of trays to suit every budget, from mid level to premium. We pride ourselves on being able to offer our customers quality manufactured products, the perfect complement for your Series shower enclosure backed up by outstanding customer service. Many of our trays feature a lifetime guarantee.

The shower trays featured in this brochure are our recommendations to compliment the Series range. To view our full range of trays, please visit www.merlynshowering.com

PREMIUM

TRUESTONE®



Ultra slim 30mm low level tray can be fitted on or level with floor

- 15 sizes available in 5 different colours

LEVEL25^{SR}



- Double Skinned
- 25mm Sleek
- Fitted or level to floor
- 21 sizes available

LEVEL25^I



- Double Skinned
- 25mm Sleek
- Fitted or level to floor
- 30 sizes available

MID LEVEL

MSTONE®



- Double Skinned
- 30 sizes available

Five Colours

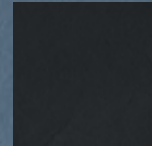

Black



Sandstone

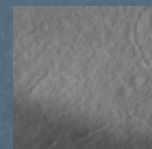

Fossil Grey



White



Graphite

Choose your Shape

Rectangular Tray



Square Tray



Quadrant Tray



Offset Quadrant Tray



Left Handed (L) Right Handed (R)
This product is handed. Please choose L for Left or R for Right when ordering.

THE ULTIMATE TRAY EXPERIENCE



Without Mershield Stayclear™

With Mershield Stayclear™



Natural glass surface.



Mershield Stayclear™ coating creates a smooth layer over the surface of natural glass, lowering surface friction, making it easier for water, soap and lime deposits to run off the glass.



MERSHIELD™
STAYCLEAR

Mershield Stayclear™

MERLYN treats every product in the Series Collection with a special protective coating to ensure the glass maintains its sparkle. This comes as standard as part of our on-going commitment to service.

Mershield Stayclear™ acts as a protective coating which when applied to glass, helps the glass to remain shiny and new without the need for tiresome cleaning. When cleaned correctly it helps prevent the build up of limescale and soap deposits making the shower glass “easy to clean”. Please see tips for keeping the glass in pristine condition.

See page 91 for cleaning tips

MERLYN Lifetime Guarantee

MERLYN is committed to developing products that meet the highest demands in terms of design, performance and quality.

Due to our extreme confidence in our products and our unrelenting desire to deliver only the highest level of service, we have created the MERLYN Lifetime Guarantee.

MERLYN shower enclosures are crafted and engineered for a lifetime.

For more about our MERLYN Lifetime Guarantee, contact our MERLYN customer service team on 0808 101 1429.

Register your MERLYN product:

To register your new MERLYN product for the Lifetime Guarantee, log on to www.merlynshowering.com and fill in your information.





MERLYN
revo

A steadying hand for all the family

revo answers your call for a sleek storage and safety system addressing the real needs of a growing and changing family today.



Kids learning to shower independently



Mothers-to-be who need a helping hand



When the unexpected happens



Caring for visiting grandparents

MERLYN revo

Features

- Customise your space in a variety of configurations. TUV tested to withstand 150kg.
- Mount highly adaptable accessory arms to the rail and easily adjust and swivel to any height or direction required.
- Accessories are retro-fittable. They can be added easily at any time to suit the changing needs of the user (without removing the rail).
- Easy cleaning - a container arm that pivots 180 degrees for easy access to tiles on all sides. Our matt textured container is fitted with a removable brushed stainless steel base for easy cleaning too.
- Versatility - Position the container on a rotatable accessory arm or even onto the rail itself for a variety of needs.
- Built to the European Inclusive Design Standard I.S EN 17161:201



* 1 year guarantee on all plastic and wearable parts
* Rail max load of 150kg / 15Nm



revo Rails (Without Accessories)

Size	Code	Description	Price £ Exc. VAT	Price £ Inc. VAT
400	RV400	Straight Rail	92.00	110.40
600	RV600	Straight Rail	108.00	129.60
800	RV800	Straight Rail	124.00	148.80
700 x 700 (90° rail)*	RV77	L Shaped Rail (Reversible)	228.00	273.60
700 x 500 (90° rail)*	RV75 (L or R)*	L Shaped Rail (Left or Right hand facing)	204.00	244.80
400 x 300 (135° rail)	RV135 (L or R)*	Arc Rail (Left or Right hand facing)	156.00	187.20

*All rails - overall depth is 70mm from the wall. When using a container depth is 106mm from wall to outside of the container. RV135(L or R) overall length is 625mm and height is 238mm.

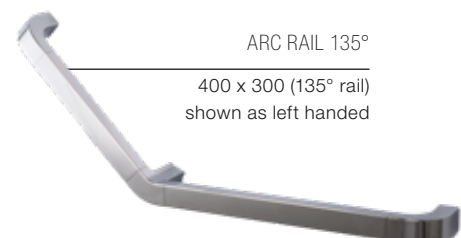

Straight Rail Bundles

Size	Code	Description	Price £ Exc. VAT	Price £ Inc. VAT
400	RV401A1C	400 Rail + 1 arm and 1 container	172.00	206.40
600	RV601A1C	600 Rail + 1 Arm & 1 Container	192.00	230.40
600	RV602A2C	600 Rail + 2 arms and 2 containers	260.00	312.00
600	RV60RISE	600 Rail + Shower Riser	212.00	254.40
600	RV60R1A1C	600 Straight Rail including 1 Arm, 1 Container & Shower Riser	212.00	254.40
800	RV801A1C	800 Rail + 1 arm and 1 container	212.00	254.40
800	RV802A2C	800 Rail + 2 arms and 2 containers	276.00	331.20
800	RV80RISE	800 Straight Rail + Shower Riser	228.00	273.60
800	RV80R1A1C	800 Straight Rail including 1 Arm, 1 Container & Shower Riser	228.00	273.60

Rail can be used in both vertical or horizontal position. Accessories Arm cannot be used when rail is in horizontal position

Arc Rail Bundles

Size	Code	Description	Price £ Exc. VAT	Price £ Inc. VAT
400 x 300	RV1351CR	Arc Rail + 1 container (Right Handed)	204.00	244.80
400 x 300	RV1351CL	Arc Rail + 1 container (Left Handed)	204.00	244.80

L Shaped Bundles

Size	Code	Description	Price £ Exc. VAT	Price £ Inc. VAT
700 x 700	RV772A2C	700 x 700 Rail + 2 arms and 2 containers	348.00	417.60
700 x 700	RV771A1C	700 x 700 Rail + 1 arm and 1 container	308.00	369.60
700 x 700	RV77H2A2C	700 x 700 L Shaped Rail including 2 Arms & 2 Containers & Hooks	360.00	432.00
700 x 500	RV751A1CL	700 x 500 Rail + 1 arm and 1 container (Left Handed)	276.00	331.20
700 x 500	RV751A1CR	700 x 500 Rail + 1 arm and 1 container (Right Handed)	276.00	331.20
700 x 500	RV752A2CL	700 x 500 Rail + 2 arm and 2 container (Left Handed)	316.00	379.20
700 x 500	RV752A2CR	700 x 500 Rail + 2 arms and 2 containers (Right Handed)	316.00	379.20
700 x 500	RV75H2A2CL	700 x 500 L Shaped Rail including 2 Arms & 2 Containers & Hooks (Left Handed)	328.00	393.60
700 x 500	RV75H2A2CR	700 x 500 L Shaped Rail including 2 Arms & 2 Containers & Hooks (Right Handed)	328.00	393.60



*Our ARC Rail is the perfect accessory for the bath. Designed as a helping hand getting in and out of the bath tub.

revo shower accessories

Flexibility, function and adaptability come to the fore, with revo shower accessories, designed to keep your shower enclosure pristine and uncluttered.

Features

- Multiple storage options - choose from an integrated storage system comprising shower accessory hooks, soap holder and shampoo holder.
- Subtle design - a matt textured white ABS plastic finish on the container and hook accessory components as well as the arm mechanism.
- Easy cleaning - a container arm that pivots 180 degrees for easy access to tiles on all sides. Our matt textured container is fitted with a removable brushed stainless steel base for easy cleaning too.
- Versatility - Position the container at any height on a rotatable accessory arm or even onto the rail itself for a variety of needs.



*1 year guarantee on all plastic and wearable parts
 * Accessory arm max load 1.5kg



Riser

revo riser can be attached to the rail and is retro-fittable. It is easy to operate with one hand. Its position can be easily adjusted on the rail.

*Shower head used for illustration purposes only.

Accessory Kits - Rail not included

Code*	Description	Price £ Exc. VAT	Price £ Inc. VAT
RV2A2C	2 accessory arm and 2 container kit	148.00	177.60
RV1A1C	1 accessory arm and 1 container kit	76.00	91.20
RVRISE	Shower head riser	36.00	43.20
RVCONT	Storage container and SS base	36.00	43.20
RVARM	Accessory arm	44.00	52.80
RVHOOK	3 hooks	12.00	14.40

Sleek Storage System

Winner of the Institute of Designers in Ireland Awards 2021 under two separate categories: Universal Design and Furniture and Lighting Design.

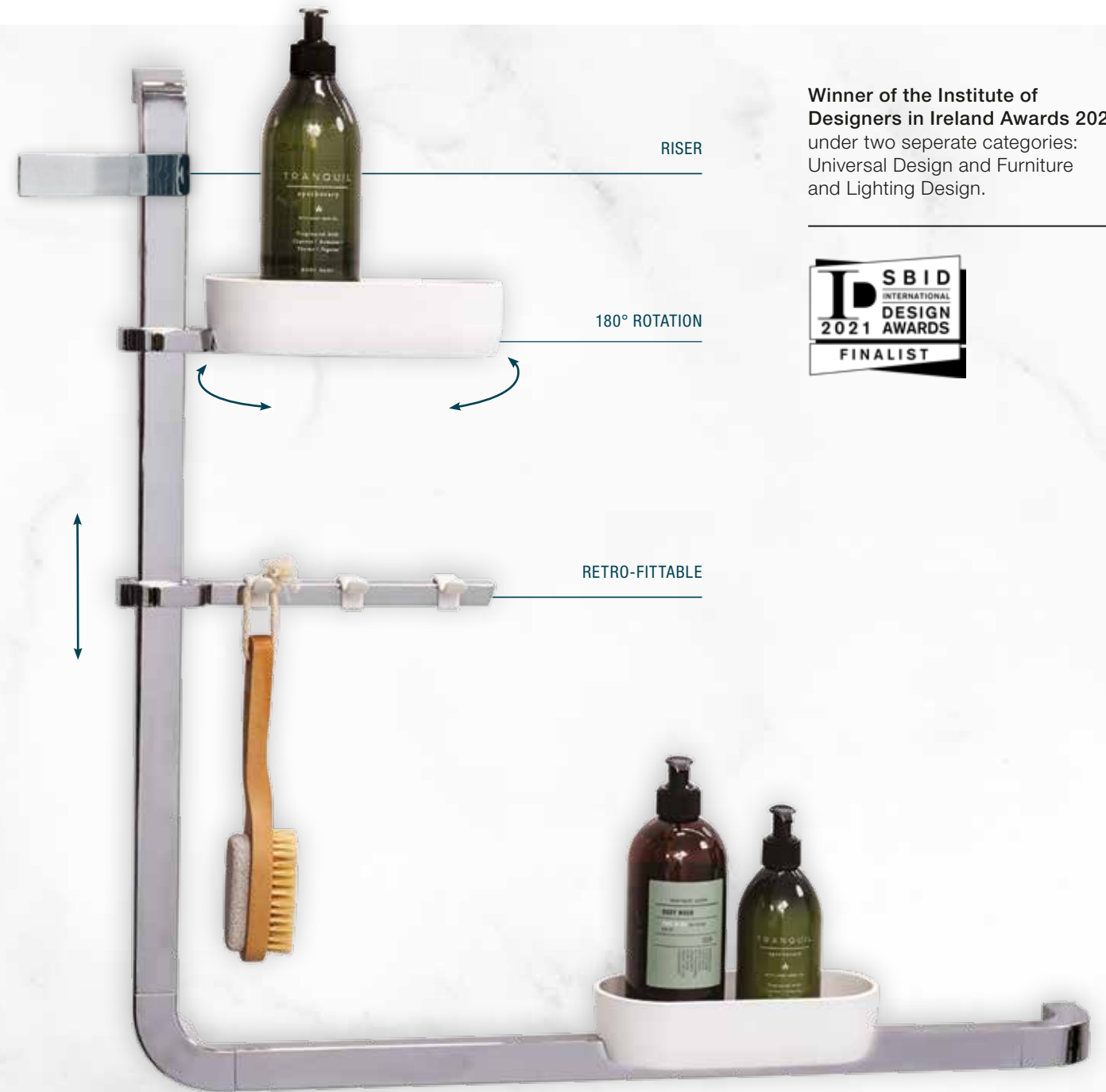

Safety Support ✓

Adaptable - at any time for all age groups ✓

Space Saving Storage System ✓

Aesthetic design for any space ✓

Retro-fittable Rail - allowing you to add arms and baskets as needed ✓

Easy Cleaning and Installation ✓



10 Series Sliding Door inRecess / Shown as Right Hand (R)



Sliding Door with Side Panel

10
MM
GLASS
THICKNESS

LIFETIME
GUARANTEE

MERSHIELD™
STAYCLEAR

10 | series

This range is the flagship of the MERLYN Series Collection, it exudes the very finest in style, luxury and quality. These beautifully designed solid doors can be personalised to suit any space and design requirements.

Why choose 10 Series?



Up to 10mm glass

Adding to the quality feel of this range, 10 Series products are manufactured using up to 10mm toughened safety glass.

Towering glass height

With up to an impressive 2100mm glass height, 10 Series gives you an amazing sense of space when showering.

A choice of handles

The 10 Series range gives you a choice of handles to suit your own personal style with both a chrome circular handle and an eyelet handle as standard with your enclosure.



Tested for quality & safety

All products are rigorously tested by us and by global health and safety experts to make sure they adhere to the highest quality standards (CE & UKCA mark info page 93).



Quiet glide wheels

Using MERLYN'S years of engineering experience, the 10 Series also features a quiet glide wheel which softly opens and closes with minimum effort.

*Please refer to adjustments and height before purchase



Sliding Door with Slide Panel / Shown as Right Hand (R)



Sliding Door in a Recess

technical drawing.



A: Opening size can be adjusted to your requirements
B: Fixed Panel

A total of 35mm adjustment (max of 12mm adjustment in wall profile on closing side for out of true walls i.e. on right hand side of image shown).

Size	A Min-Max	B
1000	300-405	510
1100	350-455	560
1200	400-505	610
1400	500-605	710
1600	500-605	910
1700	500-605	1010

10^{MM}
GLASS
THICKNESS

LIFETIME
GUARANTEE

MERSHIELD™
STAYCLEAR

Sliding Door

This spectacular enclosure makes a definite style statement, contemporary roller action. While minimalist in appearance this sliding door has an impressive 10mm toughened glass, making it the flagship of the MERLYN Series Collection range.

features.

- Height 2100mm
- Eyelet handle with chrome eyelet option and circular filler plate option
- Extra smooth roller action for quiet closing
- Door handed - order Left Hand (L) or Right Hand (R)
- Wetroom compatible
- Bespoke options available, see page 23.

Sliding Door						Add a MERLYN MStone Tray		
Size	Tray Finish Adjustment	Glass Type	Code	Price £ Exc. VAT	Price £ Inc. VAT	Code*	Price £ Exc. VAT	Price £ Inc. VAT
1000	950-985	Clear	M108231C L or R	1957.88	2349.46	MS108231C L or R	2362.07	2834.48
1100	1050-1085	Clear	M108251C L or R	1957.88	2349.46	MS108251C L or R	2399.16	2878.99
1200	1150-1185	Clear	M108241C L or R	1957.88	2349.46	MS108241C L or R	2377.67	2853.21
1400	1350-1385	Clear	M108291C L or R	2042.97	2451.56	MS108291C L or R	2628.50	3154.20
1500	1450-1485	Clear	M108281C L or R	2225.96	2671.15	MS108281C L or R	2888.26	3465.91
1600	1550-1585	Clear	M108271C L or R	2270.02	2724.02	MS108271C L or R	3031.95	3638.34
1700	1650-1685	Clear	M1081700CH L or R	2315.89	2779.07	MS1081700CH L or R	3205.45	3846.54

*Code for ordering shower enclosure with tray.

This product is handed please choose L for left and R for right when ordering.
Please add 15mm to Tray Finish Adjustment when using a Side Panel.

Optional Side Panel

Size	Tray Finish Adjustment	Glass Type	Code	Price £ Exc. VAT	Price £ Inc. VAT
760	730-750	Clear	M102210C	889.10	1066.92
800	770-790	Clear	M102211C	889.10	1066.92
900	870-890	Clear	M102221C	889.10	1066.92

Please Note: Moving panel door must close onto the side panel.

For wetroom installation, please reduce Side Panel tray finish adjustment by 20mm.



1 Door Offset Quadrant / Shown as Right Hand (R)

technical drawing.

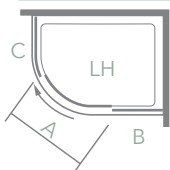

Size	A Min-Max	B	C
1000 x 800	435-340	435	520
1200 x 800	435-340	635	520
1200 x 900	485-390	635	570
1400 x 800	435-340	835	520

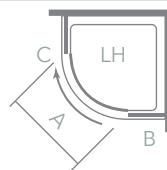

Size	A Min-Max	B	C
800	435-340	235	535
900	485-390	340	575

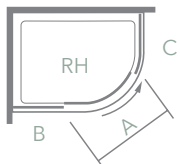

A: Opening size can be adjusted to your requirements
 B: Straight Panel
 C: Curved Panel

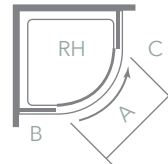

All sizes suit 550mm radius tray.
 Note: Curved Panels 8mm glass.
 Extension profiles available. See Page 95.

10_{MM}
GLASS
THICKNESS

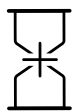

LIFETIME
GUARANTEE



MERSHIELD™
STAYCLEAR

One Door Quadrants

Beautifully curved glass combined with an exceptionally smooth roller action makes this quadrant door the best in its class. Constructed from up to 10mm toughened glass, this stunning enclosure offers strength and practicality which belies its beauty.

features.

- Height 2000mm
- Up to 10mm toughened glass
- Eyelet handle with chrome eyelet option and circular filler plate option
- Extra smooth roller action for quiet closing
- Door handed - order Left Hand (L) or Right Hand (R)
- Wetroom compatible

One Door Offset Quadrant						Add a MERLYN MStone Tray		
Size	Tray Finish Adjustment	Glass Type	Code	Price £ Exc. VAT	Price £ Inc. VAT	Code*	Price £ Exc. VAT	Price £ Inc. VAT
1000 x 800	975-995 775-795	Clear	M103233C L or R	2458.15	2949.78	MS103233C L or R	2930.30	3516.36
1200 x 800	1175-1195 775-795	Clear	M103243C L or R	2731.87	3278.24	MS103243C L or R	3235.25	3882.30
1200 x 900	1175-1195 875-895	Clear	M103241C L or R	2733.44	3280.13	MS103241C L or R	3256.42	3907.70
1400 x 800	1375-1395 775-795	Clear	M10148H L or R	2921.78	3506.13	M10148HB L or R	3496.83	4196.19

*Code for ordering shower enclosure with tray.
This product is handed please choose L for left and R for right when ordering.

MERLYN Dedicated Offset Quadrant Tray (1400x800)

Size	Code	Price £ Exc. VAT	Price £ Inc. VAT
1400 x 800	S148Q L or R	371.49	445.79

Please Note: The 1400mmx800mm tray is not an MStone Tray, it is a dedicated single skinned tray.
For wetroom installation, please reduce Side Panel tray finish adjustment by 20mm.

One Door Quadrant						Add a MERLYN MStone Tray		
Size	Tray Finish Adjustment	Glass Type	Code	Price £ Exc.VAT	Price £ Inc. VAT	Code*	Price £ Exc.VAT	Price £ Inc. VAT
800	775-795	Clear	M103211C L or R	2417.74	2901.29	MS103211C L or R	2786.42	3343.70
900	875-895	Clear	M103221C L or R	2374.01	2848.81	MS103221C L or R	2763.92	3316.70

*Code for ordering shower enclosure with tray.
For wetroom installation, please reduce Side Panel Tray Finish Adjustment by 10mm.



Pivot Door / Shown in a Recess



Pivot Door / Shown with Side Panel

technical drawing.

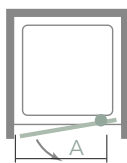

A: Door Opening
B: Door Swing

Note: 10mm adjustment only on closing side.

Extension profiles available. See Page 95.

Size	A Min-Max	B
800	560	580
900	660	680
1000	760	780



Pivot Door

The 10 Series Pivot Door is bound to impress in any bathroom. Its substantial 10mm toughened glass and solid chrome angular double handle provide a style statement that befits the beauty of this door.

features.

- Height 2030mm
- Solid chrome handle
- Fully concealed fixings
- Reversible
- Wetroom compatible

Pivot Door in a recess						Add a MERLYN MStone Tray		
Size	Tray Finish Adjustment	Glass Type	Code	Price £ Exc. VAT	Price £ Inc. VAT	Code*	Price £ Exc. VAT	Price £ Inc. VAT
800	760-790	Clear	M101211C	1674.20	2009.04	MS101211C	1951.07	2341.28
900	860-890	Clear	M101221C	1687.38	2024.86	MS101221C	2042.96	2451.56
1000	960-990	Clear	M101231C	1773.90	2128.68	MS101231C	2168.90	2602.68

*Code for ordering shower enclosure with tray.

Please reduce Tray Finish Adjustment by 10mm when using a Side Panel.

Optional Side Panel					
Size	Tray Finish Adjustment	Glass Type	Code	Price £ Exc. VAT	Price £ Inc. VAT
800	770-790	Clear	M10P2211C	832.08	998.50
900	870-890	Clear	M10P2221C	869.49	1043.39
1200	1170-1190	Clear	M10P2241C	1067.28	1280.74

Please Note: Moving panel door must close onto the Side Panel.

For wetroom installation, please reduce Side Panel Tray Finish Adjustment by 30mm.



Pivot Door & Inline Panel / Shown with Side Panel

technical drawing.

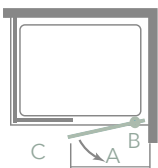

- A: Door Opening
- B: Door Swing
- C: Inline Panel

Size	A Min-Max	B	C
1200	560	580	410
1400	560	580	610
1500	660	680	810
1600	560	580	810
1700	660	680	810
1800	760	780	810

Extension profiles available. See Page 95.



10^{MM}
GLASS
THICKNESS

LIFETIME
GUARANTEE

MERSHIELD™
STAYCLEAR

Pivot Door & Inline Panel

MERLYN'S 10 Series Pivot Door & Inline Panel is a luxurious showering choice with solid chrome double handle and 10mm toughened safety glass. Flexible size options available from 1200mm to 1800mm.

features.

- Height 2030mm
- Solid chrome handle
- Fully concealed fixings
- Reversible
- Wetroom compatible

Pivot Door and Inline Panel (Glass Type: Clear)							Add a MERLYN MStone Tray		
Size	Tray Finish Adjustment	Size of Pivot Door Supplied	Size of Pivot Inline Panel Supplied	Code	Price £ Exc. VAT	Price £ Inc. VAT	Code*	Price £ Exc. VAT	Price £ Inc. VAT
1200	1150-1190	800	400	M101241C	2306.27	2767.52	MS101241C	2743.48	3292.18
1400	1350-1390	800	600	M101291C	2419.10	2902.92	MS101291C	3006.23	3607.48
1500	1450-1490	900	600	M101261C	2432.28	2918.74	MS101261C	3104.87	3725.85
1600	1550-1590	800	800	M101271C	2554.57	3065.49	MS101271C	3330.74	3996.88
1700	1650-1690	900	800	M101281C	2567.73	3081.28	MS101281C	3350.53	4020.63
1800	1750-1790	1000	800	M101218C	2654.20	3185.04	-	-	-

*Code for ordering shower enclosure with tray.

Optional Pivot Door and Inline Panel Side Panel						
Size	Tray Finish Adjustment	Glass Type	Code	Price £ Exc. VAT	Price £ Inc. VAT	
800	770-790	Clear	M10PIL2211C	824.97	989.96	
900	870-890	Clear	M10PIL2221C	889.10	1066.92	

For wetroom installation, please reduce Side Panel Tray Finish Adjustment by 10mm.
Please Note: Moving panel door must close onto the Inline Panel.



Bespoke Sliding Door and Side Panel with Satin glass and increased height / Shown as Left Hand (L)



10^{MM}
GLASS
THICKNESS



LIFETIME
GUARANTEE



MERSHIELD™
STAYCLEAR

Bespoke

- Sliding Door

Create the perfect Sliding Door to suit your space. MERLYN offer bespoke sizes for the 10 Series Sliding Door and Side Panels. With extra heights, widths and glass colour options to choose from, it's time to make your MERLYN shower truly unique to you.

For a detailed quote please contact MERLYN directly on 0808 101 1429.

Glazing Options

There are 4 glass options to choose from: Standard Clear, Smoked Black, Satin and Opti-White. Please note these are additionally priced options.

Ordering Bespoke Products

To order a bespoke product please supply a drawing with accurate measurements to MERLYN at sales@merlyn.ie or call the customer service team directly on 0808 101 1429. Please contact MERLYN for additional delivery charges on side panel sizes over 1200mm and further terms and conditions.





Bespoke Heights.

Max height available is 2200mm with minimum height of 1900mm.

Bespoke Widths.

Max width available on Sliding Door and Fixed Panel is 2000mm. Side Panels can be created from 300mm wide up to max width of 2200mm.

Glass Options.

-  Standard
-  Smoked Black
-  Satin
-  Opti-White





8 | series | *frameless*

If your bathroom is crying out for an enclosure that has a minimalist designer frame the 8 Series Frameless range is perfect. With its chrome hinges and handles, it's the perfect complement for any modern styled bathroom.

Why choose 8 Series frameless?

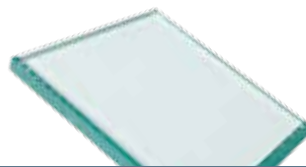

8mm glass

The 8 Series Frameless range features stunning 8mm frameless glass, standing at the impressive height of 2000mm.

MERLYN signature badging



For the designer look, the minimalist frame is complemented with subtle MERLYN embossing. A true mark of quality for you to showcase in your bathroom.

Horizontal designer handle

The Hinged and Quadrant shapes in this range feature our exclusive horizontal handle which offers the perfect symmetry and solid feel to this truly stunning range.



Tested for quality & safety

All products are rigorously tested by us and by global health and safety experts to make sure they adhere to the highest quality standards (UKCA and CE mark info page 93.)

Ultra slim hinges

Complementing the designer minimalist look, the ultra sleek one piece hinges on our 8 Series Frameless range are our most innovative to date. The internal mechanics are concealed fully in one elegant chrome plate, which gives you a secure showering environment with added style.





Pivot Door / Shown with Side Panel

Pivot Door / Shown in a Recess

technical drawing.

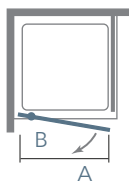

A: Door Opening
B: Door Swing

Size	A	B
760	642	640
800	682	680
900	782	780
1000	882	880

Note: 10mm adjustment only on closing side.

Extension profiles available. See Page 95.

8^{MM}
GLASS
THICKNESS

LIFETIME
GUARANTEE

MERSHIELD™
STAYCLEAR

Pivot Door

The 8 Series Frameless Pivot Door is practical, stylish and the perfect solution for recess and corner situations. At a height of 1950mm, this enclosure is the perfect choice.

features.

- Height 1950mm
- Solid chrome double handle
- Cover caps
- Space saving solution
- Inward and outward opening swing
- Concealed fixings
- Reversible
- Wetroom compatible

Pivot Door in a Recess					Add a MERLYN MStone Tray		
Size	Tray Finish Adjustment	Code	Price £ Exc. VAT	Price £ Inc. VAT	Code*	Price £ Exc. VAT	Price £ Inc. VAT
760	730-760	S8FPV76	755.33	906.39	S8FPV76B	960.05	1152.06
800	770-800	S8FPV80	783.90	940.68	S8FPV80B	1008.81	1210.57
900	870-900	S8FPV90	826.73	992.07	S8FPV90B	1128.83	1354.60
1000	970-1000	S8FPV100	855.29	1026.35	S8FPV100B	1192.58	1431.10

*Code for ordering shower enclosure with tray.

Optional Pivot Door Side Panel				
Size	Tray Finish Adjustment	Code	Price £ Exc. VAT	Price £ Inc. VAT
760	735-755	S8FSP76PV	616.83	740.19
800	775-795	S8FSP80PV	616.83	740.19
900	875-895	S8FSP90PV	653.96	784.75
1000	975-995	S8FSP100PV	749.63	899.55
1200	1175-1195	S8FSP120PV	849.58	1019.49

For wetroom installation, please reduce Side Panel Tray Finish Adjustment by 10mm.

8 Series
frameless



Pivot and Inline / Overhead Shown with a Side Panel
Inward Swing



Pivot and Inline / Overhead Shown with a Side Panel
Outward Swing



Pivot and Inline / Shown in a Recess

Pivot and Inline / Shown with Side Panel

technical drawing.

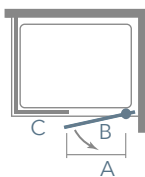

- A: Door Opening
- B: Door Swing
- C: Inline Panel

Extension profiles available.
See Page 95.

Side Panel

Enclosure Size	Door Size	Inline Size	A	B	C
1000	800	200	682	680	225
	800	300	682	680	325
1100	900	200	782	780	225
	800	400	682	680	425
1200	900	300	782	780	325
	1000	200	882	880	225
1300	800	500	682	680	525
	900	400	782	780	425
1400	1000	300	882	880	325
	900	500	782	780	525
1500	1000	400	882	880	425
	800	700	682	680	725
1600	900	700	782	780	725
1700	1000	700	882	880	725

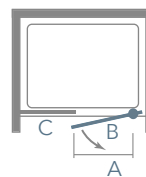

- A: Door Opening
- B: Door Swing
- C: Inline Panel

Recess

Enclosure Size	Door Size	Inline Size	A	B	C
1000	800	200	682	680	218
	800	300	682	680	318
1100	900	200	782	780	218
	800	400	682	680	418
1200	900	300	782	780	318
	1000	200	882	880	218
1300	800	500	682	680	518
	900	400	782	780	418
1400	1000	300	882	880	318
	900	500	782	780	518
1500	1000	400	882	880	418
	800	700	682	680	718
1600	900	700	782	780	718
1700	1000	700	882	880	718

8^{MM}
GLASS
THICKNESS

LIFETIME
GUARANTEE

MERSHIELD™
STAYCLEAR

Pivot Door & Inline Panel

This new addition to the 8 Series Frameless range brings with it choice and a range of size options to fit a varied space. This beautiful enclosure epitomises style and practicality.

features.

- Height 1950mm
- Solid chrome double handle
- Cover caps
- Space saving solution
- Inward and outward opening swing
- Concealed fixings
- Reversible
- Wetroom compatible

Pivot Door and Inline Panel in a Recess							Add a MERLYN MStone Tray		
Size	Size of Pivot Door	Inline Panels	Tray Finish Adjustment	Code	Price £ Exc. VAT	Price £ Inc. VAT	Code*	Price £ Exc. VAT	Price £ Inc. VAT
1000	800	200	960-1000	S8FPI1002H	1139.42	1367.30	S8FPI1002HB	1502.72	1803.26
1100	800	300	1060-1100	S8FPI1103H	1167.98	1401.58	S8FPI1103HB	1552.20	1862.65
		200		S8FPI1102H	1167.98	1401.58	S8FPI1102HB	1552.20	1862.65
1200	800	400	1160-1200	S8FPI1204H	1196.53	1435.84	S8FPI1204HB	1578.28	1893.93
		300		S8FPI1203H	1196.53	1435.84	S8FPI1203HB	1578.28	1893.93
		200		S8FPI1202H	1196.53	1435.84	S8FPI1202HB	1578.28	1893.93
** 1300	800	500	1260-1300	S8FPI1305H	1225.10	1470.12	S8FPI1305HB	1651.03	1981.24
		400		S8FPI1304H	1225.10	1470.12	S8FPI1304HB	1651.03	1981.24
		300		S8FPI1303H	1225.10	1470.12	S8FPI1303HB	1651.03	1981.24
1400	900	500	1360-1400	S8FPI1405H	1253.65	1504.38	S8FPI1405HB	1781.09	2137.31
		400		S8FPI1404H	1253.65	1504.38	S8FPI1404HB	1781.09	2137.31
1500	1000	500	1460-1500	S8FPI1505H	1282.20	1538.64	S8FPI1505HB	1876.79	2252.15
		800		S8FPI1507H	1282.20	1538.64	S8FPI1507HB	1876.79	2252.15
1600	900	700	1560-1600	S8FPI1607H	1312.20	1574.64	S8FPI160HB	1914.33	2297.19
1700	1000	700	1660-1700	S8FPI1707H	1330.72	1596.86	S8FPI170HB	1952.61	2343.13

Please Note: Items in bold are our recommended configurations.

*Code for ordering shower enclosure with tray.

**Available with TouchStone Tray Only

Please Note: If you would like the door to open fully against the wall please refer to the sizes in panel B (door swing) in the relevant table on page 29.

Optional Pivot Door and Inline Side Panel				
Size	Tray Finish Adjustment	Code	Price £ Exc. VAT	Price £ Inc. VAT
760	735-755	S8FSP76IN	616.83	740.19
800	775-795	S8FSP80IN	616.83	740.19
900	875-895	S8FSP90IN	653.96	784.75

For wetroom installation, please reduce Side Panel Tray Finish Adjustment by 10mm.

For more information on the Side Panel refer to the technical drawing page 29.

8 Series
frameless



Sliding Door / Shown with Side Panel

technical drawing.

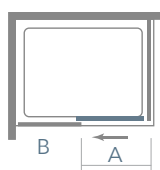

A: Door Opening
B: Fixed Panel

Size	A	B
1200	450	565
1400	550	665

8^{MM}
GLASS
THICKNESS

LIFETIME
GUARANTEE

MERSHIELD™
STAYCLEAR

Sliding Door

The 8 Series Frameless Sliding Door has the smoothest rolling action that needs to be seen to be believed. With its sleek minimalist frame and stunning designer features; it will bring a touch of class to any bathroom.

features.

- Height 2000mm
- Concealed fixings
- Mershield Stayclear™ easy clean protected glass
- Translucent seals
- Reversible
- Wetroom compatible
- Lifetime Guarantee

Sliding Door					Add a MERLYN MStone Tray		
Size	Tray Finish Adjustment	Code	Price £ Exc. VAT	Price £ Inc. VAT	Code*	Price £ Exc. VAT	Price £ Inc. VAT
1200	1150-1190	A0920DH	1288.67	1546.41	AS0920DH	1682.85	2019.41
1400	1350-1390	A0920HH	1484.78	1781.74	AS0920HH	2042.40	2450.88

*Code for ordering shower enclosure and tray.
Please add 20mm to Tray Finish Adjustment when using a Side Panel.

Optional Side Panel				
Size	Tray Finish Adjustment	Code	Price £ Exc. VAT	Price £ Inc. VAT
800	765-790	A0920LH	674.27	809.13
900	865-890	A0920PH	715.22	858.26

For wetroom installation, please reduce Side Panel tray finish adjustment by 20mm.

8 | Series
frameless



Hinge and Inline / Shown in a Recess



Hinge and Inline / Shown with Side Panel

technical drawing.

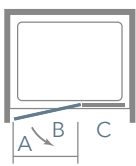

- A: Door Opening
- B: Door Swing
- C: Inline Panel

Extension profiles available. See Page 95.

Size	A	B	C
900	560	630	240
900+	560	630	285
1000	645	710	260
1000+	690	755	260
1100	645	710	360
1100+	690	755	360
1200	645	710	460

Size	A	B	C
1200+	690	755	460
1400	645	710	660
1400+	690	755	660
1600	645	710	860
1600+	690	755	860
1700	645	710	960
1700+	690	755	960

8^{MM}
GLASS
THICKNESS

LIFETIME
GUARANTEE

MERSHIELD™
STAYCLEAR

Hinge and Inline

A hugely practical yet stylish option, the 8 Series Frameless Hinge & Inline in a Recess is perfect for recesses or en suites. The Hinge and Inline redefines the art of showering with its creative fusion of style and practicality.

features.

- Height 2000mm
- Large horizontal designer handle including internal clutch bar handle
- Secure "Clunk" closing
- Ultra slim hinges
- Concealed fixings
- Reversible
- Wetroom compatible

Hinge and Inline in a Recess					Add a MERLYN MStone Tray		
Size	Tray Finish Adjustment	Code	Price £ Exc. VAT	Price £ Inc. VAT	Code*	Price £ Exc. VAT	Price £ Inc. VAT
900	860-905	A0611X0	1506.14	1807.37	A0611X0B	1852.66	2223.19
900+	905-950	A0611Y0	1506.14	1807.37	A0611Y0B	1852.66	2223.19
1000	960-1005	A0611RH	1506.14	1807.37	A0611RHB	1887.76	2265.32
1000+	1005-1050	A0611RF	1506.14	1807.37	A0611RFB	1887.76	2265.32
1100	1060-1105	A0611SH	1609.19	1931.03	A0611SHB	2014.71	2417.65
1100+	1105-1150	A0611SF	1609.19	1931.03	A0611SFB	2014.71	2417.65
1200	1160-1205	A0611TH	1631.96	1958.36	A0611THB	2035.47	2442.56
1200+	1205-1250	A0611TF	1631.96	1958.36	A0611TFB	2035.47	2442.56
1400	1360-1405	A0611UH	2048.76	2458.51	A0611UHB	2634.56	3161.47
1400+	1405-1450	A0611UF	2048.76	2458.51	A0611UFB	2634.56	3161.47
1600	1560-1605	A0611VH	2127.57	2553.09	A0611VHB	2882.39	3458.86
1600+	1605-1650	A0611VF	2127.57	2553.09	A0611VFB	2882.39	3458.86
1700	1660-1705	A0611WH	2194.07	2632.88	A0611WHB	2958.17	3549.80
1700+	1705-1750	A0611WF	2194.06	2632.87	A0611WFB	2958.17	3549.80

Please Note: Only + sizes are to be used with a Side Panel.

*Code for ordering shower enclosure with tray.

Hinge and Inline sizes must be used with Side Panel					Add a MERLYN MStone Tray		
Size	Tray Finish Adjustment	Code	Price £ Exc. VAT	Price £ Inc. VAT	Code*	Price £ Exc. VAT	Price £ Inc. VAT
900+	880-900	A0611Y0	1506.14	1807.37	A0611Y0B	1852.66	2223.19
1000+	980-1000	A0611RF	1506.14	1807.37	A0611RFB	1887.76	2265.32
1100+	1080-1100	A0611SF	1609.19	1931.03	A0611SFB	2014.71	2417.65
1200+	1180-1200	A0611TF	1631.96	1958.36	A0611TFB	2035.47	2442.56
1400+	1380-1400	A0611UF	2048.76	2458.51	A0611UFB	2634.56	3161.47
1600+	1580-1600	A0611VF	2127.57	2553.09	A0611VFB	2882.39	3458.86
1700+	1680-1700	A0611WF	2194.06	2632.87	A0611WFB	2958.17	3549.80

*Code for ordering shower enclosure with tray.

Optional Side Panel				
Size	Tray Finish Adjustment	Code	Price £ Exc. VAT	Price £ Inc. VAT
760	740-760	A0607B0	673.71	808.46
800	780-800	A0607D0	673.71	808.46
900	880-900	A0607E0	673.71	808.46

Please note: Moving panel door must close onto the Side Panel.

For wetroom installation, please reduce Side Panel tray finish adjustment by 20mm.

8 Series
frameless



Hinged Bifold Door / Shown in a Recess

Hinged Bifold Door / Shown with Side Panel

technical drawing.

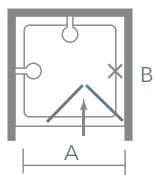

A: Door Opening
B: Width of panel when folded

Extension profiles available. See Page 95.

Size	A	B
760	520	355
800	560	375
900	670	425
1000	780	475

8^{MM}
GLASS
THICKNESS

LIFETIME
GUARANTEE

MERSHIELD™
STAYCLEAR

Hinged Bifold Door

The 8 Series Frameless Bifold is an ingenious space saving solution for bathrooms with space restrictions, the hero of the bijou bathroom. Folding away neatly and horizontally flush to the wall, this screen allows you to double your feeling of space in any small bathroom giving you that extra elbow room you desire.

features.

- Height 1950mm
- Space solution
- Frameless
- Minimalist designer hinges
- Reversible

Hinged Bifold Door					Add a MERLYN MStone Tray		
Size	Tray Finish Adjustment	Code	Price £ Exc. VAT	Price £ Inc. VAT	Code*	Price £ Exc. VAT	Price £ Inc. VAT
760	720-750	M87111	973.27	1167.92	M87111B	1184.06	1420.88
800	760-790	M87211	1006.87	1208.24	M87211B	1238.36	1486.03
900	860-890	M87221	1072.42	1286.91	M87221B	1383.84	1660.60
1000	960-990	M87231	1107.74	1329.28	M87231B	1455.30	1746.36

*Code for ordering shower enclosure and tray.
Please reduce the Tray Finish Adjustment by 5mm when using a Side Panel.

Optional Side Panel				
Size	Tray Finish Adjustment	Code	Price £ Exc. VAT	Price £ Inc. VAT
760	715-735	M82101	642.11	770.53
800	755-775	M82102	642.11	770.53
900	855-875	M82103	680.78	816.94

For wetroom installation, reduce Side Panel Tray Finish Adjustment by 5mm.
Please note: Moving panel door must close onto the Side Panel.

8 | Series
frameless



One Door Offset Quadrant / Shown with Left Hand TrueStone tray (L)

technical drawing.

One Door Offset Quadrant

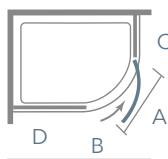

Size	A	B	C	D
900 x 760	720	790	195	335
1000 x 800	720	790	235	435
1200 x 800	720	790	235	635
1200 x 900	720	790	335	635

A: Door Opening
B: Door Swing
C: Straight Panel
D: Curved Panel

One Door Quadrant



Size	A	B	C	D
800	720	790	235	235
900	720	790	335	335
1000	720	790	435	435

All sizes to suit a 550mm Radius Tray.

Extension profiles available. See Page 95.

8^{MM}
GLASS
THICKNESS

LIFETIME
GUARANTEE

MERSHIELD™
STAYCLEAR

One Door Quadrants

The stylish 8 Series Frameless Offset Quadrant comes in a range of sizes, providing a spacious showering space that would suit any type of bathroom, traditional or contemporary.

features.

- Height 2000mm
- Large horizontal designer handle
- Secure "Clunk" closing
- Ultra slim hinges
- Concealed fixings
- Reversible
- Wetroom compatible

One Door Offset Quadrant					Add a MERLYN MStone Tray		
Size	Tray Finish Adjustment	Code	Price £ Exc. VAT	Price £ Inc. VAT	Code*	Price £ Exc. VAT	Price £ Inc. VAT
900 x 760	880-900 740-760	A0601CH	2068.95	2482.74	A0601CHB L or R	2538.86	3046.63
1000 x 800	980-1000 780-800	A0601EH	2085.34	2502.41	A0601EHB L or R	2538.86	3046.63
1200 x 800	1180-1200 780-800	A0601HH	2153.70	2584.44	A0601HHB L or R	2259.83	2711.80
1200 x 900	1180-1200 880-900	A0601IH	2153.70	2584.44	A0601IHB L or R	2647.69	3177.23

*Code for ordering shower enclosure and tray.

Tray for this product is handed. Select L for Left or R for Right when choosing.

One Door Quadrant					Add a MERLYN MStone Tray		
Size	Tray Finish Adjustment	Code	Price £ Exc. VAT	Price £ Inc. VAT	Code*	Price £ Exc. VAT	Price £ Inc. VAT
800	780-800	A0601TH	1735.81	2082.97	A0601THB	2070.37	2484.44
900	880-900	A0601UH	1735.81	2082.97	A0601UHB	2093.78	2512.54
1000	980-1000	A0602ZH	1875.91	2251.09	A0602ZHB	2323.57	2788.28

*Code for ordering shower enclosure and tray.



One Door Quadrant

8 Series
frameless



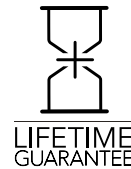

8 | series

If you are looking for a large selection of shapes to choose from, then 8 Series is the range for you. This range is a true style statement, with ingenious functionality. An excellent choice for all homeowners.

Why choose 8 Series?

8mm covered

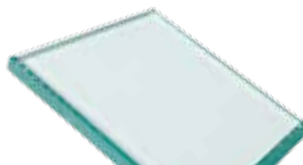

The 8mm glass in the 8 Series range is that great balance between our 10mm range and 6mm ranges. The glass is also toughened and tested rigorously to ensure maximum safety.

Easy clean double rollers

This feature on our 8 Series range is a great addition to make your enclosure the easiest to clean on the market. Simply push and release for easy cleaning in those hard to reach areas.



Every space covered

Not every space is the same, so MERLYN have designed a range of Inline Panels which can be added to standard enclosures to fit any width from 650mm to 1900mm. These ingenious semi-frameless panels, with a generous glass height of 1950mm, gives you options for almost any width you need.

Ergonomic handle

The elegantly designed internal and external handles are designed to effortlessly close the shower to a solid "Clunk" each time you shower. With a beautiful solid chrome plated finish, it adds a designer touch to your enclosure.



Tested for quality & safety

All products are rigorously tested by us and by global health and safety experts to make sure they adhere to the highest quality standards. (UKCA and CE mark info page 93).



Sliding Door / Shown with Side Panel



Sliding Door / Shown in a Recess

technical drawing.

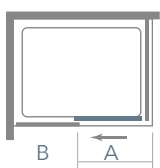

A: Door Opening
B: Fixed Panel

Extension profiles available. See Page 95.

Size	A	B
1000	390	440
1100	430	480
1200	470	530
1300	530	580
1400	570	630
1500	570	730
1600	570	830
1700	570	930



Sliding Door

The 8 Series Sliding door is an impressive and highly engineered spacious enclosure with 8mm toughened safety glass, 1950mm high and smooth gliding action based on quick release double rollers for easy cleaning.

features.

- Height 1950mm
- Translucent seals
- Concealed fixings
- Full length chrome magnetic strips
- Easy clean double rollers
- Chrome handle
- Reversible
- Wetroom compatible

Sliding Door					Add a MERLYN MStone Tray		
Size	Tray Finish Adjustment	Code	Price £ Exc. VAT	Price £ Inc. VAT	Code*	Price £ Exc. VAT	Price £ Inc. VAT
1000	950-990	M88231	1087.95	1305.53	MS88231	1448.66	1738.40
1100	1050-1090	M88251	1087.95	1305.53	MS88251	1468.17	1761.81
1200	1150-1190	M88241	1087.95	1305.53	MS88241	1491.59	1789.91
1300	1250-1290	M88240	1322.51	1587.01	MS88240	1812.96	2175.55
1400	1350-1390	M88291	1375.37	1650.45	MS88291	1927.50	2312.99
1500	1450-1490	M88261	1423.13	1707.75	MS88261	2045.30	2454.35
1600	1550-1590	M88271	1440.68	1728.81	MS88271	2161.15	2593.38
1700	1650-1690	M88281	1510.87	1813.04	MS88281	2240.85	2689.02

*Code for ordering shower enclosure and tray.

**Available with Touchstone Tray only.

Please add 20mm to Tray Finish Adjustment when using a Side Panel.

Please state tray size required when ordering. For full information on our MStone trays see page 94.

Optional Side Panel

Size	Tray Finish Adjustment	Code	Price £ Exc. VAT	Price £ Inc. VAT
700	670-690	M82201	607.58	729.09
760	730-750	M82210	607.58	729.09
800	770-790	M82211	607.58	729.09
900	870-890	M82221	644.17	773.00
1000	970-990	M82231	706.20	847.45

Sliding door can be paired with 2 optional Side Panels

For wetroom installation, please reduce Side Panel tray finish adjustment by 20mm.

Optional Inline Panel

Size	Tray Finish Adjustment	Code	Price £ Exc. VAT	Price £ Inc. VAT
150	130-150	M8P140	365.50	438.60
210	190-210	M8P2200	382.72	459.26

Inline panels can be fitted to either or both sides of Sliding Door - See page 97 for space solutions.



Hinge Door / Shown in a Recess



Hinge Door / Shown with Side Panel

technical drawing.



A: Door Opening
B: Door Swing

Size	A	B
700	550	550
760	610	610
800	650	650
900	750	750
1000	850	850

Extension profiles available. See Page 95.

8^{MM}
GLASS
THICKNESS

LIFETIME
GUARANTEE

MERSHIELD™
STAYCLEAR

Hinge Door

A practical choice for larger en suites or smaller bathrooms. The Hinge Door offers a highly specified and versatile option, making it suitable for a large range of spaces.

features.

- Height 1950mm
- Concealed fixings
- Extended length chrome design symmetry handle
- Translucent seals
- Wetroom compatible
- Minimalist exposed glass edge
- Signature hinges with internal flush fixings
- Reversible
- Double bales catch closing with definitive “Clunk” close

Hinge Door					Add a MERLYN MStone Tray		
Size	Tray Finish Adjustment	Code	Price £ Exc. VAT	Price £ Inc. VAT	Code*	Price £ Exc. VAT	Price £ Inc. VAT
700	650-690	M81201	993.87	1192.64	-	-	-
760	710-750	M81210	995.86	1195.03	MS81210	1219.30	1463.16
800	750-790	M81211	995.86	1195.03	MS81211	1238.83	1486.60
900	850-890	M81221	1102.51	1323.01	MS81221	1428.83	1714.60
1000	950-990	M81231	1167.23	1400.68	MS81231	1531.93	1838.31

*Code for ordering shower enclosure and tray.

Please add 20mm to Tray Finish Adjustment when using a Side Panel.

Optional Side Panel				
Size	Tray Finish Adjustment	Code	Price £ Exc. VAT	Price £ Inc. VAT
700	670-690	M82201	607.58	729.09
760	730-750	M82210	607.58	729.09
800	770-790	M82211	607.58	729.09
900	870-890	M82221	644.17	773.00
1000	970-990	M82231	706.20	847.45

For wetroom installation, please reduce Side Panel tray finish adjustment by 20mm.

Optional Inline Panel				
Size	Tray Finish Adjustment	Code	Price £ Exc. VAT	Price £ Inc. VAT
150	130-150	M8P140	365.50	438.60
210	190-210	M8P2200	382.72	459.26

Inline panels can be fitted to either or both sides of Hinge Door - See page 97 for space solutions.

Please Note: Moving panel door must close onto the Side Panel.



Infold Door / Shown with Side Panel



Infold Door and Inline Panel / Shown in a Recess

technical drawing.

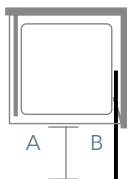

A: Door Opening
B: Door Swing

Size	A	B
700	505	200
760	565	260
800	605	300
900	705	400
1000	805	500

Extension profiles available. See Page 95.

8^{MM}
GLASS
THICKNESS

LIFETIME
GUARANTEE

MERSHIELD™
STAYCLEAR

Infold Door

This door is the epitome of space saving solutions without compromising on the beautiful lines of the glass door. Pair this 1950mm high 8 Series door with the minimalist optional Side Panel and this enclosure becomes ideal for any corner setting.

features.

- Height 1950mm
- Concealed fixings
- Chrome design symmetry handle
- Reversible
- Wetroom compatible
- Translucent seals

Infold Door					Add a MERLYN MStone Tray		
Size	Tray Finish Adjustment	Code	Price £ Exc. VAT	Price £ Inc. VAT	Code*	Price £ Exc. VAT	Price £ Inc. VAT
700	650-690	M84401	1052.87	1263.44	-	-	-
760	710-750	M84410	1070.43	1284.51	MS84410	1297.58	1557.10
800	750-790	M84411	1091.45	1309.74	MS84411	1339.19	1607.03
900	850-890	M84421	1107.06	1328.48	MS84421	1433.63	1720.35
1000	950-990	M84431	1205.03	1446.04	MS84431	1571.61	1885.93

*Code for ordering shower enclosure and tray.
Please add 20mm to Tray Finish Adjustment when using a Side Panel.

Optional Side Panel				
Size	Tray Finish Adjustment	Code	Price £ Exc. VAT	Price £ Inc. VAT
700	670-690	M82201	607.58	729.09
760	730-750	M82210	607.58	729.09
800	770-790	M82211	607.58	729.09
900	870-890	M82221	644.17	773.00
1000	970-990	M82231	706.20	847.45

For wetroom installation, please reduce Side Panel tray finish adjustment by 20mm.

Optional Inline Panel				
Size	Tray Finish Adjustment	Code	Price £ Exc. VAT	Price £ Inc. VAT
150	130-150	M8P140	365.50	438.60
210	190-210	M8P2200	382.72	459.26

Inline Panels can be fitted to either or both sides of Infold Door - See page 97 for space solutions.



Infold Door / Shown with Side Panel Overhead



One Door Offset Quadrant / Shown on Right Hand (R) 1400x800 size available

technical drawing.

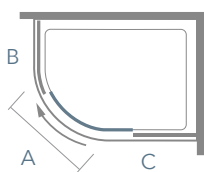

- A: Door Opening
- B: Fixed Panel
- C: Straight Panel

One Door Offset Quadrant

Size	A	B	C
900 x 760	420	465	275
1000 x 800	425	520	375
1200 x 800	425	520	575
1200 x 900	480	540	575
1400 x 800	425	520	775

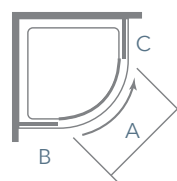

One Door Quadrant

Size	A	B	C
900 x 900	480	540	275

All sizes to suit a 550mm Radius Tray.
Extension profiles available. See Page 95.

8^{MM}
GLASS
THICKNESS

LIFETIME
GUARANTEE

MERSHIELD™
STAYCLEAR

One Door Quadrants

With fresh curved lines and designer chrome handles, the 1 Door Offset Quadrant exudes traditional style with a contemporary twist and a strong focus on expert engineering.

features.

- Height 1950mm
- Concealed fixings
- Chrome design symmetry handle
- Reversible
- Wetroom compatible
- Translucent seals

One Door Offset Quadrant					Add a MERLYN MStone Tray		
Size	Tray Finish Adjustment	Code	Price £ Exc. VAT	Price £ Inc. VAT	Code*	Price £ Exc. VAT	Price £ Inc. VAT
900 x 760	875-895 735-755	M83222	1569.21	1883.05	MS83222 L or R	2054.59	2465.51
1000 x 800	975-995 775-795	M83233	1569.21	1883.05	MS83233 L or R	1945.66	2334.79
1200 x 800	1175-1195 775-795	M83243	1582.88	1899.46	MS83243 L or R	1970.76	2364.91
1200 x 900	1175-1195 875-895	M83241	1582.88	1899.46	MS83241 L or R	2048.32	2457.98
1400 x 800	1375-1395 775-795	M83244	1587.52	1905.03	MS83244 L or R	2095.86	2515.04

*Code for ordering shower enclosure and tray.

Tray for this product is handed. Select L for Left or R for Right when choosing.

MERLYN Dedicated Offset Quadrant Tray (1400x800)			
Size	Code	Price £ Exc. VAT	Price £ Inc. VAT
1400 x 800	S148Q L or R	371.49	445.79

This tray is handed please choose L for left and R for right when ordering.
Please Note: The 1400x800mm tray is not an MStone Tray, it is a dedicated single skinned tray.
For wetroom installation, please reduce Tray Finish Adjustment by 20mm.

One Door Quadrant					Add a MERLYN MStone Tray		
Size	Tray Finish Adjustment	Code	Price £ Exc. VAT	Price £ Inc. VAT	Code*	Price £ Exc. VAT	Price £ Inc. VAT
900	875-895	M83225	1385.43	1662.51	MS83225	1725.91	2071.09

*Code for ordering shower enclosure with tray.
For wetroom installation, please reduce Tray Finish Adjustment by 20mm.



Two Door Quadrant

technical drawing.

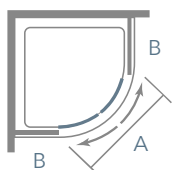

A: Door Opening
B: Fixed Panel

All sizes to suit a 550mm Radius Tray.
Extension profiles available. See Page 95.

Size	A	B
800	410	220
900	540	320
1000	540	420



8^{MM}
GLASS
THICKNESS

LIFETIME
GUARANTEE

MERSHIELD™
STAYCLEAR

Two Door Quadrant

With fresh curved lines and designer chrome handles, the Two Door Quadrant exudes traditional style with a contemporary twist and a strong focus on expert engineering.

features.

- Height 1950mm
- 8mm toughened glass
- Mershield Stayclear™ easy clean protected glass
- Lifetime Guarantee
- Translucent seals
- Concealed fixings
- Easy clean double rollers
- Chrome design symmetry handle
- Reversible
- Wetroom compatible

Two Door Quadrant					Add a MERLYN MStone Tray		
Size	Tray Finish Adjustment	Code	Price £ Exc. VAT	Price £ Inc. VAT	Code*	Price £ Exc. VAT	Price £ Inc. VAT
800	775-795	M83211	1266.32	1519.58	MS83211	1577.43	1892.91
900	875-895	M83221	1266.32	1519.58	MS83221	1600.84	1921.01
1000	975-995	M83231	1554.22	1865.07	MS83231	1985.81	2382.98

*Code for ordering shower enclosure with tray.

For wetroom installation, please reduce Tray Finish Adjustment by 20mm.



6_{MM}
GLASS
THICKNESS

LIFETIME
GUARANTEE

MERSHIELD™
STAYCLEAR

6 | series | *frameless*

An elegant range of enclosures designed to offer a frameless look for any bathroom space. The beautifully crafted hinges and stabilising bars would suit both contemporary or traditionally styled bathrooms.

Why choose 6 Series frameless?

Discreet designer stabilising bar

This range offers a designer bracing bar that blends seamlessly into the glass, ensuring a secure and frameless feature within your bathroom.



Luxury solid metal handle

This range ensures minimalist elegance in every detail, including the luxury solid metal handle that comes as standard.



Fusion of elegance and functionality

This range offers a towering glass height of 2000mm while maintaining its luxurious frameless design.



Stabilising Bar



Hinge and Inline / Shown with Side Panel

technical drawing.

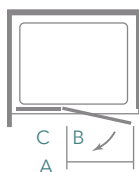

- A: Door Opening
- B: Door Swing
- C: Fixed Panel

Extension profiles available. See Page 95.

Size	A	B	C
760	440	460	160
800	440	460	200
900	490	510	250
1000	540	560	300
1100	590	650	350
1200	590	650	450
1400	590	650	650
1500	590	650	750

6^{MM}
GLASS
THICKNESS

LIFETIME
GUARANTEE

MERSHIELD™
STAYCLEAR

Hinge and Inline

The new 6 Series Frameless Hinge & Inline Door is the perfect fusion between minimalist elegance and practical functionality. The luxuriously frameless design combined with the precision engineered chrome hinge, makes this a real statement piece.

features.

- Height 2000mm
- 6mm toughened glass
- 8mm inline panel
- Mershield Stayclear™ easy clean protected glass
- Luxury solid metal handle
- Sleek designer bracing bar
- Lifetime Guarantee
- Reversible

Hinge & Inline in a Recess					Add a MERLYN MStone Tray		
Size	Tray Finish Adjustment	Code	Price £ Exc. VAT	Price £ Inc. VAT	Code*	Price £ Exc. VAT	Price £ Inc. VAT
800	760-800	S6F800REC	829.00	994.80	S6FB800REC	1091.73	1310.07
800+	800-840	S6F800CORN	829.00	994.80	S6FB800CORN	1091.73	1310.07
900	860-900	S6F900REC	855.00	1026.00	S6FB900REC	1203.75	1444.50
1000	960-1000	S6F1000REC	935.00	1122.00	S6FB1000REC	1306.82	1568.18
1000+	1000-1040	S6F1000CORN	935.00	1122.00	S6FB1000CORN	1306.82	1568.18
1100	1060-1100	S6F1100RECH	975.00	1170.00	S6FB1100RECH	1394.85	1673.82
1200	1160-1200	S6F1200RECH	999.00	1198.80	S6FB1200RECH	1407.35	1688.82
1400	1360-1400	S6F1400RECH	1079.00	1294.80	S6FB1400RECH	1636.73	1964.08
1500	1460-1500	S6F1500RECH	1088.00	1305.60	S6FB1500RECH	1755.32	2106.38

Hinge & Inline sizes for use with Side Panel					Add a MERLYN MStone Tray		
Size	Tray Finish Adjustment	Code	Price £ Exc. VAT	Price £ Inc. VAT	Code*	Price £ Exc. VAT	Price £ Inc. VAT
800+	780-800	S6F800CORN	829.00	994.80	S6FB800CORN	1091.73	1310.07
1000+	980-1000	S6F1000CORN	935.00	1122.00	S6FB1000CORN	1306.82	1568.18

Optional Side Panel to match + sizes only				
Size	Tray Finish Adjustment	Code*	Price £ Exc. VAT	Price £ Inc. VAT
760	720-760	S6F760SP	399.00	478.80
800	760-800	S6F800SP	428.00	513.60
900	860-900	S6F900SP	546.00	455.00

For Wetroom installation please reduce min / max adjustment by 10mm.







6^{MM}
GLASS
THICKNESS

LIFETIME
GUARANTEE

MERSHIELD™
STAYCLEAR

6 | series

The 6 Series range is the perfect choice if you are looking for a portfolio of shower enclosures to accommodate any space and design requirements.

Why choose 6 Series?

Easy clean double rollers

This feature on our 6 Series range makes your enclosure the easiest to clean on the market. Simply push and release for easy cleaning in those hard to reach areas.



A great range at a great price

The MERLYN 6 Series range offers all the benefits, design and technology of the Series Collection but at more accessible prices. This range delivers on style, function and value for money.

Chrome dual handle

A luxurious chrome dual handle complements the look of this framed range of enclosures with a discreet inside handle and larger external handle for easy closing.



Tested for quality & safety

All products are rigorously tested by us and by global health and safety experts to make sure they adhere to the highest quality standards. (UKCA and CE mark info page 93).

Every space covered

Not every space is the same, so MERLYN have designed a range of Inline Panels which can be added to standard enclosures to fit any width from 670mm to 1915mm. These ingenious semi-frameless panels, with a generous glass height of 1900mm, gives you options for almost any width you need.



Sliding Door / Shown with Side Panel

Sliding Door / Shown in a Recess

technical drawing.

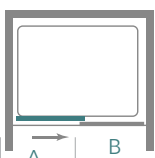

A: Door Opening
B: Fixed Panel

Extension profiles available. See Page 95.

Size	A	B
1000	380	420
1100	430	470
1200	480	520
1400	580	620
1500	580	720
1600	580	820
1700	580	920



Sliding Door

The 6 Series Sliding Door has been enhanced with designer handles and quick release double rollers for easy access cleaning. With exceptionally smooth opening, this enclosure which stands at 1900mm high is affordable yet incredibly stylish.

features.

- Height 1900mm
- 6mm toughened glass
- Translucent seals
- Full length chrome magnetic strips
- Easy clean double rollers
- Double handed
- Can be used with 2 optional minimalist Side Panels
- Reversible
- Wetroom compatible

Sliding Door					Add a MERLYN MStone Tray		
Size	Tray Finish Adjustment	Code	Price £ Exc. VAT	Price £ Inc. VAT	Code*	Price £ Exc. VAT	Price £ Inc. VAT
1000	950-1000	M68231	776.01	931.22	MS68231	1121.14	1345.37
1100	1050-1100	M68251	776.01	931.22	MS68251	1140.65	1368.78
1200	1150-1200	M68241	776.01	931.22	MS68241	1136.72	1364.06
1400	1350-1400	M68291	952.52	1143.02	MS68291	1483.49	1780.19
1500	1450-1500	M68261	1014.45	1217.34	MS68261	1616.16	1939.39
1600	1550-1600	M68271	1071.75	1286.10	MS68271	1773.78	2128.53
1700	1650-1700	M68281	1071.75	1286.10	MS68281	1891.67	2270.00

*Order code for ordering shower enclosure and tray.
Please add 20mm to Tray Finish Adjustment when using a Side Panel.

Optional Side Panel				
Size	Tray Finish Adjustment	Code	Price £ Exc. VAT	Price £ Inc. VAT
700	680-705	M62201N	441.77	530.13
760 / 800	745-790	M62211N	397.58	477.09
900	875-900	M62221N	423.07	507.68
1000	975-1000	M62231N	468.96	562.75

Sliding door can be paired with 2 optional Side Panels
For wetroom installation, please reduce Side Panel tray finish adjustment by 20mm.

Optional Inline Panel				
Size	Tray Finish Adjustment	Code	Price £ Exc. VAT	Price £ Inc. VAT
140	115-140	M61125	346.57	415.89
215	190-215	M61200	363.97	436.76

Inline panels can be fitted to either or both sides of Sliding Door. See page 96 for space solutions.



Pivot Door / Shown with Side Panel

Pivot Door

At 1900mm high the 6 Series Pivot Door is a chic space saving solution. The 8mm toughened safety glass door pivots on elegant chrome mechanisms and with the addition of the minimalist glass edged side panel, it's perfect for any corner situation.

features.

- Height 1900mm
- Double bales catch closing with definitive "Clunk" close
- Solid metal minimalist pivots
- Translucent seals
- Easy clean double rollers
- Double handed
- Reversible
- Wetroom compatible



Pivot Door					Add a MERLYN MStone Tray		
Size	Tray Finish Adjustment	Code	Price £ Exc. VAT	Price £ Inc. VAT	Code*	Price £ Exc. VAT	Price £ Inc. VAT
700	670-720	M61201N	559.01	670.82	-	-	-
760/800	740-790	M61211N	629.37	755.25	MS61211	834.48	1001.37
900	850-900	M61221N	659.79	791.75	MS61221	963.99	1156.79
1000	950-1000	M61231N	695.50	834.60	MS61231	1036.60	1243.92

*Code for ordering shower enclosure and tray. Please add 10mm to Tray Finish Adjustment when using a Side Panel.

Optional Side Panel				
Size	Tray Finish Adjustment	Code	Price £ Exc. VAT	Price £ Inc. VAT
700	680-705	M62201N	441.77	530.13
760 / 800	745-790	M62211N	397.58	477.09
900	875-900	M62221N	423.07	507.68
1000	975-1000	M62231N	468.96	562.75

Sliding door can be paired with 2 optional Side Panels For wetroom installation, please reduce Side Panel tray finish adjustment by 20mm.

Optional Inline Panel				
Size	Tray Finish Adjustment	Code	Price £ Exc. VAT	Price £ Inc. VAT
140	115-140	M6i125	346.57	415.89
215	190-215	M6i200	363.97	436.76

Inline panels can be fitted to either or both sides of Sliding Door. See page 108 for space solutions.

technical drawing.

Size	A	B
700	410	410
760 / 800	480	480
900	590	590
1000	690	690

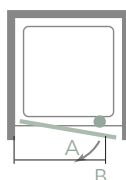

A: Door Opening
B: Door Swing

Note: Side Panel is 6mm glass
Extension profiles available. See Page 95.



Bifold Door

Where space is at a premium the 6 Series Bifold is the ultimate solution. This new version of a classic shape, offers a sleek frameless design with a discreet chrome hinge detail.

features.

- Height 1900mm
- Discreet chrome bifold hinge
- Sleek frameless door design
- Reversible
- Wetroom compatible



Bifold Door					Add a MERLYN MStone Tray		
Size	Tray Finish Adjustment	Code	Price £ Exc. VAT	Price £ Inc. VAT	Code*	Price £ Exc. VAT	Price £ Inc. VAT
700	670-720	M67201N	867.91	1041.49	-	-	-
760 / 800	740-790	M67211N	867.91	1041.49	M67211B	1084.95	1301.95
900	850-900	M67221N	930.28	1116.34	M67221B	1188.57	1426.28
1000	950-1000	M67231N	978.41	1174.09	M67231B	1270.15	1524.18

*Code for ordering shower enclosure and tray. Can be used with 2 optional minimalist Side Panels. Please add 10mm to Tray Finish Adjustment when using a Side Panel.

Optional Side Panel				
Size	Tray Finish Adjustment	Code	Price £ Exc. VAT	Price £ Inc. VAT
700	680-705	M62201N	441.77	530.13
760 / 800	745-790	M62211N	397.58	477.09
900	875-900	M62221N	423.07	507.68
1000	975-1000	M62231N	468.96	562.75

Sliding door can be paired with 2 optional Side Panels For wetroom installation, please reduce Side Panel tray finish adjustment by 20mm.

Optional Inline Panel				
Size	Tray Finish Adjustment	Code	Price £ Exc. VAT	Price £ Inc. VAT
140	115-140	M6I125	346.57	415.89
215	190-215	M6I200	363.97	436.76

Inline panels can be fitted to either or both sides of Sliding Door. See page 108 for space solutions.

technical drawing.

Size	A
700	420
760 / 800	490
900	600
1000	650

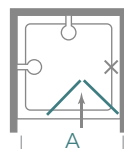

X: Do not put shower head here
A: Door Opening

Extension profiles available. See Page 95.



One Door Quadrant

Quadrants

The 6 Series Quadrants have it all – 1900mm high with a beautifully curved chrome frame, 6mm toughened glass, designer handles and quick release double rollers for easy access to clean – stylish yet very affordable.

features.

- Height 1900mm
- Translucent seals
- Easy clean double rollers
- Double handed
- Single sliding door
- Reversible
- Wetroom compatible

One Door Quadrant					Add a MERLYN MStone Tray		
Size	Tray Finish Adjustment	Code	Price £ Exc. VAT	Price £ Inc. VAT	Code*	Price £ Exc. VAT	Price £ Inc. VAT
900	875-900	M63225	1004.51	1205.41	MS63225	1325.95	1591.14

One Door Offset Quadrant					Add a MERLYN MStone Tray		
Size	Tray Finish Adjustment	Code	Price £ Exc. VAT	Price £ Inc. VAT	Code*	Price £ Exc. VAT	Price £ Inc. VAT
900 x 760	875-900 735-760	M63222	1115.60	1338.72	MS63222 L or R	1466.80	1760.16
1000 x 800	975-1000 775-800	M63233	1325.64	1590.77	MS63233 L or R	1658.27	1989.92
1200 x 800	1175-1200 775-800	M63243	1323.44	1588.12	MS63243 L or R	1672.73	2007.28
1200 x 900	1175-1200 875-900	M63241	1325.60	1590.72	MS63241 L or R	1693.54	2032.25

*Order code for ordering shower enclosure with tray.
For wetroom installation, please reduce tray finish adjustment by 20mm.

6^{MM}
GLASS
THICKNESS

LIFETIME
GUARANTEE

MERSHIELD™
STAYCLEAR

technical drawing.

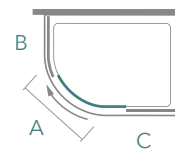

- A: Door Panel
- B: Curved Panel
- C: Straight Panel

All sizes to suit a 550mm Radius Tray.
Extension profiles available. See Page 95.



Corner Door / Shown with side Panel

Corner Door

The 6 Series Corner door is a functional and contemporary enclosure. It is the perfect solution for bijou en suites or awkward spaces as the doors slide back within the confines of the shower itself.

features.

- Height 1900mm
- Translucent seals
- Easy clean double rollers
- Double handed
- Double sliding doors
- Reversible
- Wetroom compatible

Corner Door					Add a MERLYN MStone Tray		
Size	Tray Finish Adjustment	Code	Price £ Exc. VAT	Price £ Inc. VAT	Code*	Price £ Exc. VAT	Price £ Inc. VAT
800	775-800	M65211	973.71	1168.45	MS65211	1157.67	1389.20
900	875-900	M65221	1071.63	1285.95	MS65221	1329.92	1595.90

*Code for ordering shower enclosure with tray.

For wetroom installation, please reduce Tray Finish Adjustment by 20mm.

6^{MM}
GLASS
THICKNESS

LIFETIME
GUARANTEE

MERSHIELD™
STAYCLEAR

technical drawing.

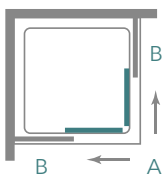

Size	A	B
800	395	310
900	465	360

A: Door Opening

B: Fixed Panel

Extension profiles available. See Page 95.



10^{MM}
GLASS
THICKNESS

8^{MM}
GLASS
THICKNESS

LIFETIME
GUARANTEE

MERSHIELD™
STAYCLEAR



Wetrooms

MERLYN Wetrooms offer you the ultimate in versatility and luxury. Whether you are after the New York style loft appeal or you need to create a bathroom with inclusive design, then Wetroom Panels are the solution for you.

Why choose MERLYN Wetrooms?

Choice of glass

Available in 10mm and 8mm glass and up to a height of 2015mm, the MERLYN Wetrooms offer you choice to suit our space.

A solution for every situation

The MERLYN Wetrooms provide several additional options to complement your wetroom panels for whatever you need to achieve within your bathroom.

A Wetroom even for small spaces

The MERLYN Single and Double Folding wetroom panels are the solution to create a wetroom finish within bathrooms that have space restrictions. MERLYN offer you a solution for every space.



Wetrooms 10 | series



10 Series Wetroom Panel / with Wall Profile only



Wetroom / with Cube Panel (F)



Wetroom / with Vertical Post (G)

Wetroom Panels



Luxurious Wetroom Panels, crafted with our signature 10mm glass. Each Wetroom panel comes with a wall profile you can tailor with various options such as; stabilising bars, end, swivel or cube panels and flush wall and floor profiles. Pick and choose from the 9 additional options to give your wetroom the luxurious finish.

features.

- Height 2000mm
- 10mm toughened glass
- Mersfield Stayclear™ easy clean protected glass
- Choice of additional options to tailor your wetroom to suit your space
- Suitable for a recess or corner situation
- Suitable for wetroom and shower tray application
- Lifetime Guarantee
- Reversible

10 Series wetroom Panels (including Wall Profile only)						Wetroom Panels with Straight Stabilising Bar (including Wall Profile)			
Size	Tray Finish Adjustment	Glass Type	Code	Price £ Exc. VAT	Price £ Inc. VAT	Additional Option	Code*	Price £ Exc. VAT	Price £ Inc. VAT
300**	275-290	Clear	S10SW300	387.89	465.47	A	S10SW300H	622.22	746.66
400**	375-390	Clear	S10SW400	415.47	498.56	A	S10SW400H	633.31	759.97
500**	475-490	Clear	S10SW500	494.25	593.10	A	S10SW500H	712.09	854.51
600**	575-590	Clear	S10SW600	554.49	665.39	A	S10SW600H	772.33	926.80
700**	675-690	Clear	S10SW700	585.37	702.44	A	S10SW700H	803.22	963.86
800**	775-790	Clear	S10SW800	616.27	739.52	A	S10SW800H	834.10	1000.92
900**	875-890	Clear	S10SW900	647.16	776.59	A	S10SW900H	865.01	1038.01
1000	975-990	Clear	S10SW1000	662.62	795.14	A	S10SW1000H	880.44	1056.53
1100	1075-1090	Clear	S10SW1100	708.96	850.75	A	S10SW1100H	926.78	1112.14
1200	1175-1190	Clear	S10SW1200	755.27	906.32	A	S10SW1200H	973.11	1167.73
1400	1375-1390	Clear	S10SW1400	832.51	999.01	A	S10SW1400H	1050.34	1260.41

*Code for ordering shower enclosure with tray.
 **Please Note: These sizes are the only sizes we recommend for use as end panels. We recommend a minimum opening space of 500mm.

Additional Options				
	Size	Code**	Price £ Exc. VAT	Price £ Inc. VAT
A) Angled Stabilising Bar	350	SP08SCU12320	136.00	163.20
B) Straight Stabilising Bar*	max 1 metre	SP0S8TRSET N	217.42	260.90
C) Vertical Ceiling Bracing Bar***	400	CBB440	191.33	229.60
D) T Bracket (to connect 2 stabilising bars)	N/A	SP0S8RTPSET	70.30	84.36
E) Swivel Panel 8mm glass	300	M8SWS30 N	375.19	450.23
F) Cube Panel 8mm glass**	300	A0413F0 N	217.88	261.45
G) Vertical Post	max 3 metres	A0417C0 N	213.75	256.50
H) U channel	max 1400	MGVC35A	38.29	45.95

*Please Note: We recommend the use of a stabilising bar for any wetroom panel over 900mm.
 **Cube Panel must be fitted on a flat tray/wetroom situation.
 ***Please note: Max height of ceiling bar from top of glass is 400mm.

Additional Options	
I) Flush Wall Profile	SP02000FWP
J) Flush Floor Profile	SP01400FFP

*Please Note: These are available as bespoke options. Please contact Customer Services for sizes and prices.



Wetrooms 10 | series

Wetrooms 8 | series



8 Series Wetroom Panel / with Wall Profile only

Corner Profile



Wetroom Panel / with Swivel Panel (B)



Wetroom Panel / with Cube Panel (C)



Wetroom Panel / with Vertical Post (D)

Wetroom Panels



The 8 Series Wetroom Panels are stylish yet functional by design. With frameless 8mm toughened safety glass, these panels stands at an impressive 2015mm high, including rail and are suitable for a recess or a corner situation. They are guaranteed to make a statement in any bathroom.

features.

- Height 2015mm including rail
- Suitable for wetroom and shower tray application
- 1M Stabilising bar comes as standard with all sizes
- Suitable for recess or corner situation
- Reversible

Wetroom Panels					Add a MERLYN MStone Tray			
Size	Tray Finish Adjustment	Code	Price £ Exc. VAT	Price £ Inc. VAT	Tray Size	Code*	Price £ Exc. VAT	Price £ Inc. VAT
700	670-690	M8SW201	794.44	953.33	1200x900	MS8SW201	1127.06	1352.47
800	770-790	M8SW211	824.30	989.16	1400x900	MS8SW211	1284.63	1541.56
900	870-890	M8SW221	862.96	1035.55	1400x900	MS8SW221	1342.25	1610.70
1000	970-990	M8SW231	873.53	1048.24	1500x900	MS8SW231	1398.28	1677.94
1200	1170-1190	M8SW241	920.99	1105.18	1680x760	MS8SW241	1544.22	1853.06

*Order code for ordering shower enclosure with tray. Please state the tray size required when order. For full information on our MStone trays see page 94. 1000mm stabilising bar comes as standard with all products.

Additional Options				
	Size	Code**	Price £ Exc. VAT	Price £ Inc. VAT
A) Angled Stabilising Bar	350	SP08SCU12320	136.00	163.20
B) Swivel Panel	300	M8SWS30 N	375.19	450.23
C) Cube Panel 8mm glass**	300	A0413F0 N	217.88	261.45
D) Vertical Post	max 3 metres	A0417C0 N	213.75	256.50
E) Corner profile-Glass to glass profile	2000	A04S0003	63.32	75.98
F) Vertical Ceiling Bracing Bar***	400	CBB440	191.33	229.60

*Please Note: We recommend the use of a stabilising bar for any Wetroom Panels over 900mm.

**Cube Panel must be fitted on a flat tray/wetroom situation.

***Please note: Max height of ceiling bar from top of glass is 400mm.

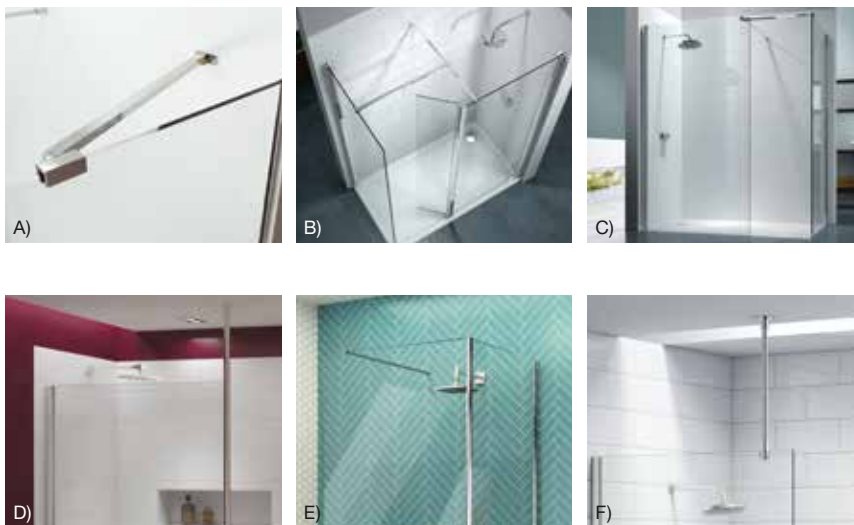

Wetrooms
8 | series

Wetrooms 8 | series



Pivot Wetroom Panel / Single



Pivot Wetroom Panel / Double

Pivot Wetroom Panels

- *Single and Double*



The 8 Series Pivot Wetroom panels offers you the choice of a single wetroom panel, perfect for tight spaces, or a double wetroom panel which creates an enclosed corner situation. Choices to create the space you desire.

features.

- Height 1950mm
- Solid chrome double handle
- Cover caps
- Space saving solution
- Inward and outward opening swing
- Concealed fixings
- Reversible
- Wetroom compatible

Pivot Wetroom Panels / Single				
Size	Adjustment	Code	Price £ Exc. VAT	Price £ Inc. VAT
760	690-710	S8FPV76	755.33	906.39
800	730-750	S8FPV80	783.90	940.68
900	830-850	S8FPV90	826.73	992.07
1000	930-950	S8FPV100	855.29	1026.35

Please Note: We recommend fitting this product in a Wetroom situation only.

Pivot Wetroom Panels / Double				
Size	Adjustment	Code	Price £ Exc. VAT	Price £ Inc. VAT
760 x 760	690-710	S8FPC76H	1566.35	1879.62
800 x 800	730-750	S8FPC80H	1623.47	1948.17
900 x 900	830-850	S8FPC90H	1709.14	2050.97
1000 x 1000	930-950	S8FPC100H	1766.26	2119.51

Please Note: We recommend fitting this product in a Wetroom situation only.



Curved Wetroom Panel



Wetroom Panel with Curved Hinged Panel

Curved Wetroom

- & Hinged Panels



The beautiful curved glass of the new 8 Series Curved Wetroom panel follows the contour of your offset quadrant tray, giving a softer finish. The extra length of the curved panel also deflects water spray inwards. This frameless design boasts Mershield Stayclear, ensuring peace of mind with the Merlyn Lifetime Guarantee.

features.

- Height 2015mm including rail
- Minimalist frameless design
- Reversible
- Folds flush with shower panel
- Suitable for wetroom and shower tray application
- Can be used with 800mm and 900mm trays
- Swivel Panel swings inwards only to deflect shower spray

Curved Wetroom Panels					Add a MERYLN MStone Tray			
Size	Tray Finish Adjustment	Code*	Price £ Exc. VAT	Price £ Inc. VAT	Tray Size	Code*	Price £ Exc. VAT	Price £ Inc. VAT
900	885-900	S8CURV900	1072.12	1286.54	900 x 900	S8CURV900B	1490.95	1789.14
1000	985-1000	S8CURV1000	1130.95	1357.14	1000 x 800	S8CURV1000B L or R	1460.37	1752.44
1200	1185-1200	S8CURV1200	1233.90	1480.68	1200 x 900	S8CURV1200B L or R	1460.37	1752.44

*Code for ordering shower enclosure with tray. Tray for this product is handed. Please choose L for Left Handed and R for Right Handed.

technical drawing

Panel Size	Tray Size	A	B	C
900	900 x 900	810	275	600
1000	1000 x 800	910	275	500
1200	1200 x 800	1110	275	500
	1200 x 900	1110	275	600

We recommend a minimum opening of 500mm.

Curved Wetroom Panel Foot		
Code	Price £ Exc. VAT	Price £ Inc. VAT
S8CSWLEG	116.34	139.60

This foot allows for greater stability on rectangular trays and sloped wetroom floors.

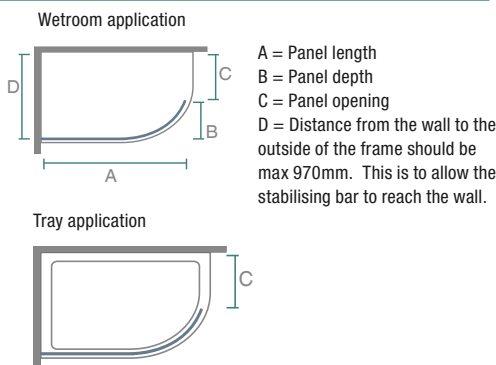

Curved Hinged Wetroom Panels					
Size	Front Panel	Hinged Panel	Code	Price £ Exc. VAT	Price £ Inc. VAT
1000	700	300	M8SWC700	926.68	1112.01
1200	900	300	M8SWC900	983.80	1180.56

A = Front Panel	B = Hinged Panel
700	300
900	300

Curved Hinged Wetroom Panel

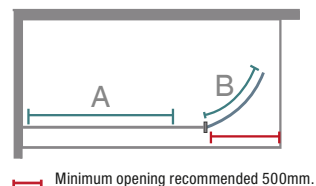



Wetroom panel with Hinged Swivel Panel

Hinged Swivel Panels



The 8 Series Hinged Swivel Panel features 2 beautifully crafted designer hinges that give this door a stunning frameless and minimalist finish. The stylish yet understated model is flexible in terms of options and is available with or without an End Panel.

features.

- Height 2015mm including rail
- Minimalist frameless design
- Reversible
- Swivel Panel can be adjusted to deflect shower spray
- Suitable for wetroom and shower tray application

Wetroom Panels with Hinged Swivel Panels						Add a MERLYN MStone Tray			
Size	Front Panel	Swivel Panel	Code	Price £ Exc. VAT	Price £ Inc. VAT	Tray Size	Code*	Price £ Exc. VAT	Price £ Inc. VAT
1050	700	350	M8SW251	942.27	1130.72	1200 x 900	M8SW1100HB	1256.28	1507.54
1250	900	350	M8SW261	995.53	1194.64	1400 x 900	M8SW1200HB	1474.83	1769.80
						1500 x 900	M8SW1300HB	1520.28	1824.34
1350	1000	350	M8SW271	1020.51	1224.61	1500 x 900	M8SW1400HB	1545.26	1854.31
						1600 x 900	M8SW1500HB	1638.06	1965.67

*Code for ordering shower enclosure with tray. Please Note: We recommend a minimum opening space of 500mm.

Walk In with Hinged Swivel Panels						Add a MERLYN MStone Tray			
Area	Panel Size (Front+Swivel+End Panel)	Opening	Code	Price £ Exc. VAT	Price £ Inc. VAT	Tray Size	Code*	Price £ Exc. VAT	Price £ Inc. VAT
1200 x 800	700+350+800	500	M8SWS100H	1766.58	2119.89	1200 x 800	M8SW100HB	2080.58	2496.70
1200 x 900	700+350+900	500	M8SWS400H	1805.22	2166.26	1200 x 900	M8SW600HB	2137.83	2565.40
1400 x 800	900+350+800	500	M8SWS200H	1819.83	2183.80	1400 x 800	M8SW200HB	2280.17	2736.20
1400 x 800	900+350+800	600				1500 x 800	M8SW300HB	2461.82	2954.18
1400 x 900	900+350+900	500	M8SWS500H	1858.51	2230.21	1400 x 900	M8SW700HB	2337.79	2805.35
1500 x 900	900+350+900	600				1500 x 900	M8SW800HB	2383.26	2859.91
1500 x 800	1000+350+800	500	M8SWS300H	1844.80	2213.76	1500 x 800	M8SW400HB	2369.56	2843.47
1600 x 800	1000+350+800	600				1600 x 800	M8SW500HB	2462.36	2954.83
1500 x 900	1000+350+900	500	M8SWS600H	1883.47	2260.16	1500 x 900	M8SW900HB	2408.22	2889.86
1600 x 900	1000+350+900	600				1600 x 900	M8SW1000HB	2501.03	3001.24

Please Note: We recommend a minimum opening space of 500mm.



Folding Wetroom Panel / Single



Folding Wetroom Panel / Double - closed

Folding Wetroom Panels

- Single and Double



The 8 Series Folding Wetroom panel is an ingenious space saving solution for bathrooms with space restrictions. The hero of the bijou bathroom. Folding away neatly and horizontally flush to the wall, this screen allows you to double your feeling of space in any small bathroom giving you that space you desire.

features.

- Height 1950mm
- Minimalist frameless design
- Suitable for wetroom situation only
- Reversible
- Space solution
- Minimalist designer hinges

Folding Wetroom Panels				
Size	Adjustment	Code	Price £ Exc. VAT	Price £ Inc. VAT
760	680-700	M87111	973.27	1167.92
800	720-740	M87211	1006.87	1208.24
900	820-840	M87221	1072.42	1286.91
1000	920-940	M87231	1107.74	1329.28

Please Note: We recommend fitting this product in a Wetroom situation only.

Double Folding Wetroom Panels				
Size	Adjustment	Code	Price £ Exc. VAT	Price £ Inc. VAT
760 x 760	715-735	M86101H	1889.83	2267.80
800 x 800	755-775	M86102H	1955.09	2346.11
900 x 900	855-875	M86103H	2082.38	2498.86
1000 x 1000	955-975	M86104H	2150.94	2581.13

Please Note: We recommend fitting this product in a Wetroom situation only.



Folding Wetroom Panel / Double - open

6
MM
GLASS
THICKNESS

LIFETIME
GUARANTEE

MERSHIELD™
STAYCLEAR

How SecureSeal works

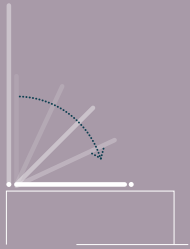

01.
Pull down arm
from storage
position.

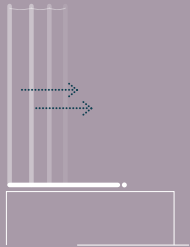

02.
Extend screen and
locate panels.

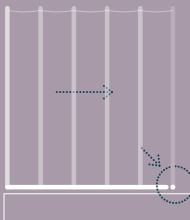

03.
Fully extend and
clip into position
for a secure fit
and tight seal.

SecureSeal.

by MERLYN

The Ultimate Leak-free Bath Screen

The SecureSeal by MERLYN has been designed with a leak free sealing arm which extends from the profile to create a complete seal between the bath and screen. When not in use the arm simply folds away back into the profile.

SecureSeal by MERLYN offers functional and easy to use designs to complement any bathroom space. With glass screen heights of 1500mm and 6mm glass, our SecureSeal by MERLYN range allows you to enjoy peace of mind in a leak free shower experience for years to come.

This range has been designed with the same superb materials and unrelenting attention to detail demonstrated across all MERLYN ranges.



4 Fold



4 Fold with Fixed Panel



5 Fold



5 Fold with Fixed Panel



Single Panel



Single Panel with Fixed Panel



Single Panel				
Size	Adjustment	Code	Price £ Exc. VAT	Price £ Inc. VAT
800 x 1500	780-800	MS1	335.75	402.90



A: Moving Panels (screen width when folded into the bath 712mm)
 Recommended shower head position



Single Panel with storage				
Size	Adjustment	Code	Price £ Exc. VAT	Price £ Inc. VAT
800 x 1500	780-800	MS1	335.75	402.90

Optional SecureSeal Fixed Panel				
Size	Adjustment	Code	Price £ Exc. VAT	Price £ Inc. VAT
300 x 1500	300-320	MSFP	265.59	318.70



A: Moving Panels (screen width when folded into the bath 712mm) B: Fixed Panel
 Recommended shower head position



SecureSeal / Fixed Panel



4 Fold				
Size	Adjustment	Code	Price £ Exc. VAT	Price £ Inc. VAT
800 x 1500	780-800	MS4	560.54	672.65

Optional SecureSeal Fixed Panel				
Size	Adjustment	Code	Price £ Exc. VAT	Price £ Inc. VAT
300 x 1500	300-320	MSFP	265.59	318.70



A: Moving Panels (screen width when folded into the bath 228mm)
 Recommended shower head position



SecureSeal / Fixed Panel



5 Fold				
Size	Adjustment	Code	Price £ Exc. VAT	Price £ Inc. VAT
1000 x 1500	980-1000	MS5	630.86	757.04

Optional SecureSeal Fixed Panel				
Size	Adjustment	Code	Price £ Exc. VAT	Price £ Inc. VAT
300 x 1500	300-320	MSFP	265.59	318.70



A: Moving Panels (screen width when folded into the bath 228mm)
 Recommended shower head position



SecureSeal / Fixed Panel

Bath Screens

4_{MM}
GLASS
THICKNESS

6_{MM}
GLASS
THICKNESS

8_{MM}
GLASS
THICKNESS

LIFETIME
GUARANTEE

MERSHIELD™
STAYCLEAR

BATH SCREENS

Innovative design and contemporary aesthetics bring this bathroom favourite to life. This modern collection has been created with the same superb materials and unrelenting attention to detail demonstrated across all **MERLYN** ranges.

Why choose MERLYN Bath Screens?

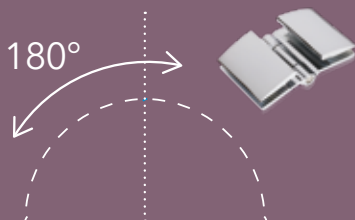

180° inwards swing

The signature piece of this range, the Two Panel Hinged Bath Screen features a secure 180° inwards swing which means you can position the glass where you can comfortably deflect water into the bath and not on to the floor!



Tested for quality & safety

All products are rigorously tested by us and by global health and safety experts to make sure they adhere to the highest quality standards. (UKCA and CE mark info page 107).

Rise and fall

All Merlyn Bath Screens have a rise and fall hinge to make it easier for you to open.

Cleaning

- It is important to clean your MERLYN Bath Screen after every use. Wipe down all the glass and metal parts with a soft cloth.
- Do not allow limescale to build up in hard water areas.
- Ensure that any residual water on the glass is removed after every use.
- Clean the glass regularly using soapy water.
- Do not use abrasive products on any surfaces.



Product Information

- MERLYN Bath Screens are not designed to fit on baths with stepped fronts, roll top rims or integral soap dishes.
- Fitting of screen on baths which have raised head rests or shapes is not recommended.
- There must be no items causing obstruction with the seal and bath, as any of the above may cause leaks.
- When choosing your Bath Screen, please ensure that if your bath has bath handles, they do not interfere with the bath rim area where your screen will be placed.
- When choosing an in-swing or folding Bath Screen, please ensure your swing area is not interfering with any brassware or internal shower features. Similarly, when choosing an out-swing, please ensure the out-swing area is free from any obstructions.
- The MERLYN MB7 2 Panel Hinged Bath Screen is handed so please ensure you state whether you require a right or left handed configuration when ordering.
- It is recommended the shower head position is situated on the same wall to which the Bath Screen is fixed and in the centre of the shower area.



19 Bath Screens to choose from

Whether you are looking for a fresh modern angular style shower screen or a minimalist curved frameless screen, we have a great choice of styles, panel options, open and close features in this range of MERLYN Bath Screens.

Great space saving features

Featuring both design and functionality the 2 Panel Curved Bath Screen is the ultimate in space efficiency. With a sleek chrome towel rail and fitted internal shelves, this piece combines style with purpose for in bath showering.

HydraSEAL

We have created an exciting new feature, exclusive to MERLYN Bath Screens called HydraSEAL

HydraSEAL acts as an extra barrier, sealing the gap between the seal and the pivot point where water can usually escape.

It contains a high density foam that compresses onto the bath screen to form a tight seal and restricts water escaping from this problem area.

HydraSEAL is now available on our MB1, MB2, MB3, MB3A and MB3B bath screens.

HydraSEAL creates a barrier to restrict leaking!



Bath Screens 6mm



MB0
Bathscreen

6mm
GLASS
THICKNESS
LIFETIME
GUARANTEE

Fixed Square				
Size	Panel	Code	Price £ Exc. VAT	Price £ Inc. VAT
800 x 1500	1	MB0	159.92	191.91

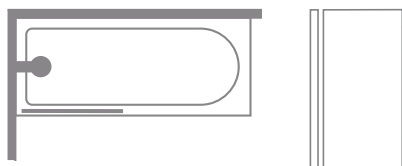

 Recommended shower head position



MB1
Bathscreen

6mm
GLASS
THICKNESS
LIFETIME
GUARANTEE

Now featuring
HydraSEAL

Single Curved				
Size	Panel	Code	Price £ Exc. VAT	Price £ Inc. VAT
800 x 1500	1	MB1	218.27	261.92

Easy-Fit Bundle Available - See page 83

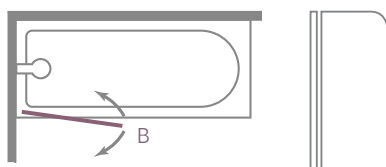

Door Swing: 90° in and out
B: Radius of Screen Swing = 733mm
 Recommended shower head position



MB2
Bathscreen

6mm
GLASS
THICKNESS
LIFETIME
GUARANTEE
MERSEBOLD
STAYCLEAR

Now featuring
HydraSEAL

Single Square				
Size	Panel	Code	Price £ Exc. VAT	Price £ Inc. VAT
800 x 1500	1	MB2	258.20	309.85

Easy-Fit Bundle Available - See page 83

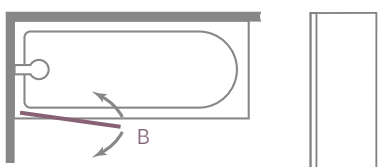

Door Swing: 90° in and out
B: Radius of Screen Swing = 733mm
 Recommended shower head position



Single Square				
Size	Panel	Code	Price £ Exc. VAT	Price £ Inc. VAT
800 x 1500	1	MB2T	324.30	389.16

Includes Towel Rail

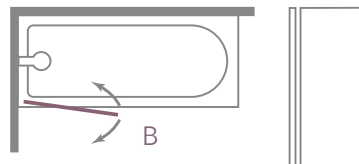

Door Swing: 90° in and out

B: Radius of Screen Swing = 733mm

☉ Recommended shower head position



2 Panel Curved				
Size	Panel	Code	Price £ Exc. VAT	Price £ Inc. VAT
1150 x 1500	2	MB3	610.16	732.20

Easy-Fit Bundle Available - See page 83

Includes Towel Rail

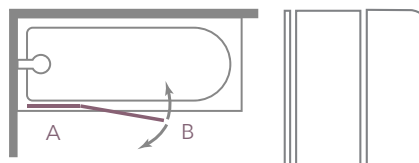

Door Swing: 90° in and out

A: Fixed Panel B: Radius of Screen Swing = 733mm

☉ Recommended shower head position



2 Panel Folding Curved				
Size	Panel	Code	Price £ Exc. VAT	Price £ Inc. VAT
900 x 1500	2	MB3A	360.68	432.82

Easy-Fit Bundle Available - See page 83

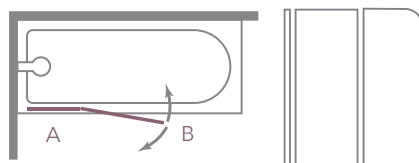

Door Swing: 90° in and out

A: Fixed Panel B: Radius of Screen Swing = 483mm

☉ Recommended shower head position

Bath Screens 4mm and 6mm



2 Panel Folding Square				
Size	Panel	Code	Price £ Exc. VAT	Price £ Inc. VAT
900 x 1500	2	MB3B	360.68	432.82

Easy-Fit Bundle Available - See page 83

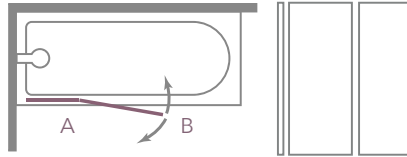

Door Swing: 90° in and out
 A: Fixed Panel B: Radius of Screen Swing = 483mm
 ○ Recommended shower head position



2 Panel Hinged				
Size	Panel	Code	Price £ Exc. VAT	Price £ Inc. VAT
900 x 1500	2	MB3C	360.68	432.82

Easy-Fit Bundle Available - See page 83

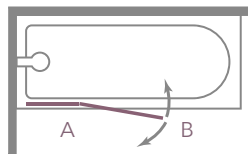

Door Swing: 90 Degrees in and out
 A: Fixed Panel = 471mm
 B: Radius of Screen Swing = 383mm
 ○ Recommended shower head position



4 Fold				
Size	Panel	Code	Price £ Exc. VAT	Price £ Inc. VAT
850 x 1400	4	MB4	428.47	514.16

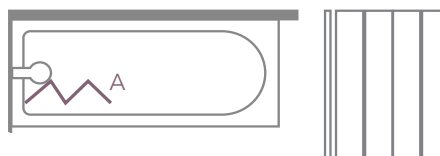

A: Moving Panels (Panel width 200mm)
 ○ Recommended shower head position

MB5
Bathscreen

6mm GLASS THICKNESS
LIFETIME GUARANTEE



Curtain Rail

Size	Panel	Code	Price £ Exc. VAT	Price £ Inc. VAT
300 x 1500	1	MB5	287.09	344.51

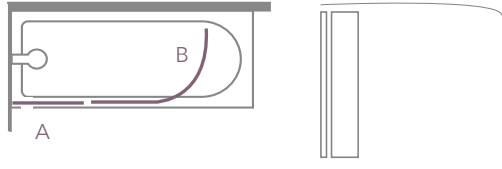

Height is 1550mm including rail
 A: Fixed Panel B: Curtain Rail
 ☐ Recommended shower head position

MB5a
Bathscreen

6mm GLASS THICKNESS
LIFETIME GUARANTEE



Curtain Rail

Size	Panel	Code	Price £ Exc. VAT	Price £ Inc. VAT
300 x 1800	1	MB5A	287.09	344.51

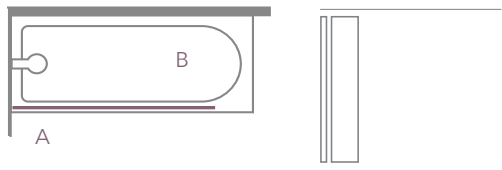

Height is 1550mm including rail
 A: Fixed Panel B: Curtain Rail
 ☐ Recommended shower head position

MB13
Bathscreen

6mm GLASS THICKNESS
LIFETIME GUARANTEE



2 Panel Folding

Size	Panel	Code	Price £ Exc. VAT	Price £ Inc. VAT
1100 x 1500	2	MB13	565.03	678.03

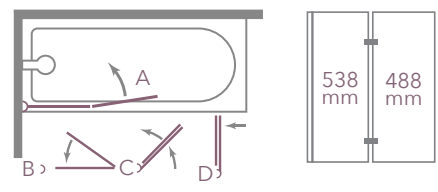

Door Swing: 180 degree radius of screen swing inwards only
 ☐ Recommended shower head position

Bath Screens 8mm



MB6
Bathscreen

8mm GLASS THICKNESS
LIFETIME GUARANTEE
MERSFIELD STAYCLEAR

Hinged Square				
Size	Panel	Code	Price £ Exc. VAT	Price £ Inc. VAT
850 x 1500	1	MB6	573.93	688.72

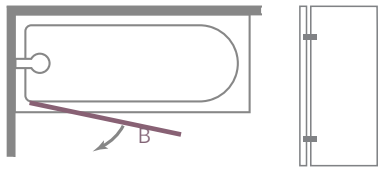

Door Swing: 90° outward swing only
 B: Radius of Screen Swing = 810mm
 ○ Recommended shower head position



MB7
Bathscreen

8mm GLASS THICKNESS
LIFETIME GUARANTEE
MERSFIELD STAYCLEAR

2 Panel Hinged				
Size	Panel	Code	Price £ Exc. VAT	Price £ Inc. VAT
900 x 1500	2	MB7L (L/H)	699.54	839.45
900 x 1500	2	MB7R (R/H)	699.54	839.45

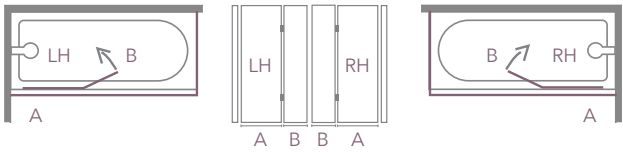

Door Swing: 180 Degrees inwards only
 A: Fixed Panel = 497mm
 B: Radius of Screen Swing = 383mm
 ○ Recommended shower head position



MB7a
Bathscreen

8mm GLASS THICKNESS
LIFETIME GUARANTEE
MERSFIELD STAYCLEAR

2 Panel Hinged				
Size	Panel	Code	Price £ Exc. VAT	Price £ Inc. VAT
850 x 1500	2	MB7AL (L/H)	672.66	807.19
850 x 1500	2	MB7AR (R/H)	672.66	807.19

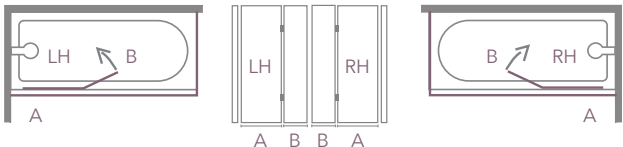

Door Swing: 180 Degrees inwards only
 A: Fixed Panel = 505mm
 B: Radius of Screen Swing = 290mm
 ○ Recommended shower head position



MB8
Bathscreen

8mm GLASS THICKNESS
LIFETIME GUARANTEE
MERLYN'S STAYCLEAR

2 Panel Folding				
Size	Panel	Code	Price £ Exc. VAT	Price £ Inc. VAT
1100 x 1500	2	MB8	695.76	834.91

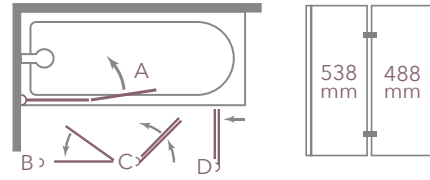

Door Swing: 180 degree radius of screen swing inwards and outwards
 Recommended shower head position



MB9
Bathscreen

8mm GLASS THICKNESS
LIFETIME GUARANTEE
MERLYN'S STAYCLEAR

3 Panel Folding				
Size	Panel	Code	Price £ Exc. VAT	Price £ Inc. VAT
1400 x 1500	3	MB9	870.08	1044.10

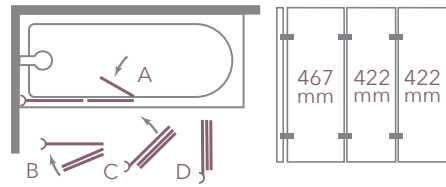

Door Swing: 180 degree radius of screen swing inwards and outwards
 Recommended shower head position



MB10
Bathscreen

8mm GLASS THICKNESS
LIFETIME GUARANTEE
MERLYN'S STAYCLEAR

Single Square				
Size	Panel	Code	Price £ Exc. VAT	Price £ Inc. VAT
800 x 1500	1	MB10	565.03	678.03

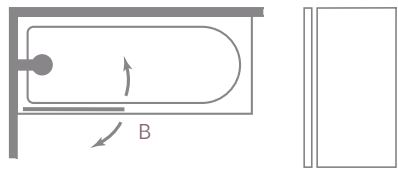

Door Swing: 90° in and out
 B: Radius of Screen Swing = 740 mm
 Recommended shower head position

Bath Screens 8mm



MB11
Bathscreen



Single Curved Panel				
Size	Panel	Code	Price £ Exc. VAT	Price £ Inc. VAT
800 x 1500	1	MB11	494.22	593.07

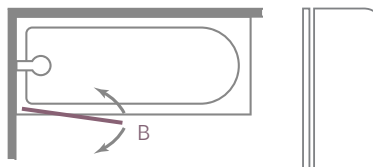

Door Swing: 90° in and out
 B: Radius of Screen Swing = 740mm
 ○ Recommended shower head position



MB14
Bathscreen



Fixed Square Panel				
Size	Panel	Code	Price £ Exc. VAT	Price £ Inc. VAT
800 x 1500	1	MB14	281.80	338.16

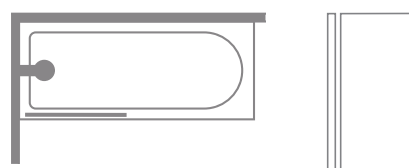

Fixed Panel
 ○ Recommended shower head position

Easy-Fit Bundles

Single Curved				
Size	Panel	Code	Price £ Exc. VAT	Price £ Inc. VAT
800 x 1500		MB1FLEX	279.31	335.17

Single Square				
Size	Panel	Code	Price £ Exc. VAT	Price £ Inc. VAT
800 x 1500		MB2FLEX	317.67	381.20

2 Panel Curved				
Size	Panel	Code	Price £ Exc. VAT	Price £ Inc. VAT
1150 x 1500		MB3FLEX	656.06	787.27

2 Panel Folding Curved				
Size	Panel	Code	Price £ Exc. VAT	Price £ Inc. VAT
900 x 1500		MB3AFLEX	416.18	499.42

2 Panel Folding Square				
Size	Panel	Code	Price £ Exc. VAT	Price £ Inc. VAT
900 x 1500		MB3BFLEX	416.18	499.42

2 Panel Hinged				
Size	Panel	Code	Price £ Exc. VAT	Price £ Inc. VAT
900 x 1500		MB3CFLEX	416.18	499.42

MERLYN

EASY-FIT

An innovative way to replace your bath screen without the need to re-drill the wall. Simply connect your easy-fit to the existing holes in the wall and install your new bath screen.

Fitting Steps

1 REMOVE THE OLD PROFILE

Easy-Fit profile



1



2

2 POSITION THE EASY-FIT PROFILE ON THE WALL



Slide bracket up to align with hole

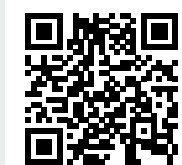

Scan me to see more

3

3 ADJUST THE BRACKETS TO ALIGN TO THE EXISTING HOLES AND FIX IN POSITION



Available with the MB1 / MB2 / MB3 / MB3A / MB3B and MB3C Bath Screens

TRUESTONE®

Luxurious textured slate trays

Beautifully handcrafted and ultra-low slate trays, elegant in appearance and luxurious to touch. With 5 finishes to choose from - Black, Sandstone, Graphite, White, and Fossil Grey.

These trays will bring an element of natural beauty and a truly designer finish to your bathroom.



Feature Highlights

- Ultra slim: Only 30mm in height
- Handcrafted from high grade stone resin
- 5 colour options - Black, Sandstone, Graphite, White and Fossil Grey
- Integrated discreet waste
- Luxurious textured finish
- Can be fitted on or level with floor
- Comes with 90mm fast flow waste
- Our self cleaning vortex design: Offers a maintenance free solution as it doesn't require any cleaning
- Please Note: Images are for illustrative purposes only. The colours and finishes shown in the catalogue are as accurate as possible within the limits of the printing process.

DISCLAIMER

Please ensure that the shower head is not positioned directly over the waste as this may restrict flow rate.



Choose your Colour



White
Code W



Fossil Grey
Code F



Graphite
Code G

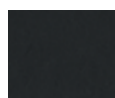

Black
Code B



Sandstone
Code S

All tray codes need the corresponding colour code at the end. (See below) e.g. T108RTW

Rectangular Tray (comes with MERLYN 90mm fast flow waste)

Size	Code	Price £ Exc. VAT	Price £ Inc. VAT
1000 x 800	T108RT	620.28	744.33
1200 x 800	T128RT	734.84	881.81
1200 x 900	T129RT	825.31	990.38
1400 x 800	T148RT	816.67	980.01
1400 x 900	T149RT	898.50	1078.19
1500 x 800	T158RT	864.12	1036.94
1500 x 900	T159RT	1099.81	1319.77
1600 x 800	T168RT	923.04	1107.65
1600 x 900	T169RT	1191.43	1429.72
1700 x 800	T178RT	1013.07	1215.69
1700 x 900	T179RT	1230.71	1476.86

All tray codes need the corresponding colour code at the end. (See below) e.g. T108RTW

Quadrant Tray (comes with MERLYN 90mm fast flow waste)

Size	Code	Price £ Exc. VAT	Price £ Inc. VAT
900 x 900	T90Q	584.26	701.11

All tray codes need the corresponding colour code at the end. (See below) e.g. T90QG

Offset Quadrant Tray (comes with MERLYN 90mm fast flow waste)

Size	Code	Price £ Exc. VAT	Price £ Inc. VAT
1000 x 800	T108H L or R	766.27	919.52
1200 x 900	T129H L or R	898.50	1078.19

All tray codes need the corresponding colour code at the end. (See below) e.g. T108HW

Square Tray (comes with MERLYN 90mm fast flow waste)

Size	Code	Price £ Exc. VAT	Price £ Inc. VAT
900 x 900	T90RT	653.01	783.61

All tray codes need the corresponding colour code at the end. (See below) e.g. T90RTW

TrueStone
trays



Ultra slim tray 30mm

Please see page 94 for important tray information.

LEVEL25⁺-SR Slip resistant trays

We have carried out all the testing to give you and your family the peace of mind of showering in a safe environment and the splendour of this natural stone effect.



Scan me for more information



Exceeds Class C for DIN 51097 - Barefoot ramp test. This ranks MERLYN in a premium class.



LEVEL25⁺

Feature Highlights

- Ultra slim 25mm low level tray
- Sleek minimalist design
- Discreet integrated waste cover
- Can be fitted on or level with floor
- Comes with 90mm fast flow waste
- Shower tray 25 year guarantee
- Available in square, rectangular and quadrant



EASY CLEAN

All you need is a soft cloth and warm soapy water.

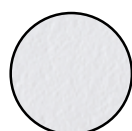

QUALITY LOOK AND FEEL

The luxury satin look and feel is designed to give confidence while not feeling harsh underfoot.



25 YEARS GUARANTEE

Level 25 Tray

1. Top acrylic capped ABS layer
2. Stone Resin
3. Bottom ABS layer (encapsulates the tray)



Level25-SR rectangle tray

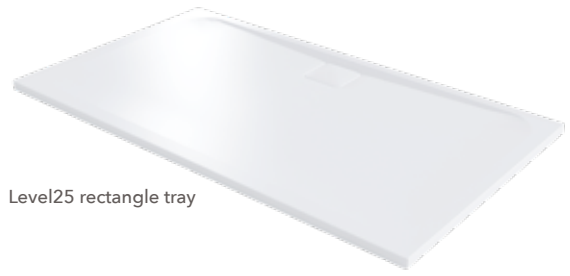

Level25 rectangle tray

Slip Resistant Tray

LEVEL25^{SR}

Rectangular Tray (comes with MERLYN 90mm fast flow waste)

Size	Code	Price £ Exc. VAT	Price £ Inc. VAT
1000 x 800	L108RTAS	527.44	632.92
1000 x 900	L109RTAS	575.59	690.71
1100 x 800	L118RTAS	575.59	690.71
1100 x 900	L119RTAS	575.59	690.71
1200 x 800	L128RTAS	575.59	690.71
1200 x 900	L129RTAS	599.69	719.63
1300 x 800	L138RTAS	857.30	1028.76
1300 x 900	L139RTAS	857.30	1028.76
1400 x 760	L1476RTAS	857.30	1028.76
1400 x 800	L148RTAS	857.30	1028.76
1400 x 900	L149RTAS	857.30	1028.76
1500 x 800	L158RTAS	922.40	1106.88
1500 x 900	L159RTAS	922.40	1106.88
1600 x 800	L168RTAS	960.95	1153.14
1600 x 900	L169RTAS	960.95	1153.14
1700 x 800	L178RTAS	1093.39	1312.06
1700 x 900	L179RTAS	1100.63	1320.75

Offset Quadrant Tray (comes with MERLYN 90mm fast flow waste)

Size	Code	Price £ Exc. VAT	Price £ Inc. VAT
1200 x 900	L129QLAS	846.35	1015.63
1200 x 900	L129QRAS	846.35	1015.63

Quadrant Tray (comes with MERLYN 90mm fast flow waste)

Size	Code	Price £ Exc. VAT	Price £ Inc. VAT
900 x 900	L90QAS	616.99	740.39

Square Tray (comes with MERLYN 90mm fast flow waste)

Size	Code	Price £ Exc. VAT	Price £ Inc. VAT
900 x 900	L90SQAS	527.44	632.92



Square tray

Standard Tray

LEVEL25[®]

Rectangular Tray (comes with MERLYN 90mm fast flow waste)

Size	Code	Price £ Exc. VAT	Price £ Inc. VAT
1000 x 800	L108RT	376.74	452.09
1000 x 900	L109RT	411.14	493.37
1100 x 800	L118RT	411.14	493.37
1100 x 900	L119RT	411.14	493.37
1200 x 760	L1276RT	411.14	493.37
1200 x 800	L128RT	411.14	493.37
1200 x 900	L129RT	428.35	514.02
1300 x 800	L138RT	612.37	734.85
1300 x 900	L139RT	612.37	734.85
1400 x 760	L1476RT	612.37	734.85
1400 x 800	L148RT	612.37	734.85
1400 x 900	L149RT	612.37	734.85
1500 x 800	L158RT	658.86	790.63
1500 x 900	L159RT	658.86	790.63
1600 x 800	L168RT	686.38	823.65
1600 x 900	L169RT	686.38	823.65
1700 x 760	L1776RT	686.38	823.65
1700 x 800	L178RT	780.99	937.19
1700 x 900	L179RT	786.16	943.40

Offset Quadrant Tray (comes with MERLYN 90mm fast flow waste)

Size	Code	Price £ Exc. VAT	Price £ Inc. VAT
1200 x 900	L129QL	604.54	725.45
1200 x 900	L129QR	604.54	725.45

Quadrant Tray (comes with MERLYN 90mm fast flow waste)

Size	Code	Price £ Exc. VAT	Price £ Inc. VAT
900 x 900	L90Q	440.72	528.86

Square Tray (comes with MERLYN 90mm fast flow waste)

Size	Code	Price £ Exc. VAT	Price £ Inc. VAT
900 x 900	L90SQ	376.74	452.09



Right Handed Handling

Please see page 94 for important tray information.



Function with style

The MStone double skin stone resin tray is sleek and sophisticated in design. A highly engineered tray providing rigidity and strength, combined with a relatively low weight. MStone trays are ideal for 'low level' installation. Alternatively, you can raise your tray. In such cases you will need the MStone shower tray panel kit. MStone panel kits are available separately.

The MStone tray is capped with an easy to clean surface that provides a chemical resistant, anti-bacterial solution due to its ultra-smooth, non-porous surface.



THE MSTONE TRAY IS CAPPED WITH AN EASY TO CLEAN SURFACE THAT PROVIDES A CHEMICAL RESISTANT, ANTI-BACTERIAL SOLUTION DUE TO IT'S ULTRA-SMOOTH, NON-POROUS SURFACE.

Why choose MStone Trays?



Fast flow waste
90mm fast flow waste, includes hair trap and chrome cover.



Adjustable leg system
Graduated adjustable leg system. Bottom acrylic capped ABS layer.



Easy fit tray panel
Graduated adjustable leg and easy fit tray panel kit.



MStone Tray
1. Top Acrylic capped ABS layer
2. Stone Resin
3. Bottom ABS layer (encapsulates the tray)

Feature Highlights

- Double skinned for added rigidity
- 50mm high to achieve minimalist design
- 130mm high including tray panel set
- The MStone tray is capped with an easy to clean surface that provides a chemical resistant, anti-bacterial solution due to its ultra-smooth non-porous surface.
- Comes with 90mm fast flow waste
- More than 30 sizes available
- Available as low level or with tray panel kits for easy installation
- Shower tray Lifetime Guarantee*

*This guarantee covers manufacturing defects only.



Rectangular Tray

Rectangular Tray (comes with MERLYN 90mm fast flow waste)				
Size	Tray Panel Kit (Order Separately)	Code	Price £ Exc. VAT	Price £ Inc. VAT
900 x 760	Kit 4	D976RT	260.10	312.12
1000 x 800	Kit 4	D108RT	298.02	357.62
1100 x 760	Kit 4	D1176RT	329.33	395.19
1100 x 800	Kit 4	D118RT	316.75	380.09
1200 x 700	Kit 4	D127RT	312.98	375.57
1200 x 760	Kit 4	D1276RT	312.98	375.57
1200 x 800	Kit 4	D128RT	320.48	384.58
1200 x 900	Kit 4	D129RT	339.20	407.04
1400 x 800	Kit 3	D148RT	467.81	561.38
1400 x 900	Kit 3	D149RT	486.89	584.27
1500 x 700	Kit 3	D157RT	532.66	639.19
1500 x 800	Kit 3	D158RT	532.66	639.19
1500 x 900	Kit 3	D159RT	532.66	639.19
1600 x 800	Kit 3	D168RT	624.73	749.68
1600 x 900	Kit 3	D169RT	626.11	751.33
1685 x 700	Kit 3	D177RT	631.85	758.22
1680 x 760	Kit 3	D1776RT	631.85	758.22
*1700 x 800	Kit 3	D178RT	742.07	890.48

Tray Panel Kit (including Legs)				
	Kit 3	DRK3	131.96	158.35
	Kit 4	DRK4	131.96	158.35



*Waste is centered for 1700 x 800 tray - D178RT

Tray Panel Kit (including Legs)				
	Kit 1	DRK1	131.96	158.35

Waste Complete				
		DWAS	131.96	158.35

White Waste Cap Option				
		DWASCAPWHT	18.70	22.43

Please see page 94 for important tray information.



Square Tray

Square Tray (comes with Merlyn 90mm fast flow waste)				
Size	Tray Panel Kit (Order Separately)	Code	Price £ Exc. VAT	Price £ Inc. VAT
760	Kit 4	D76SQ	170.76	204.91
800	Kit 4	D80SQ	189.48	227.38
900	Kit 4	D90SQ	264.34	317.21

Tray Panel Kit (including Legs)				
	Kit 4	DRK4	131.96	158.35



Quadrant Tray

Quadrant Tray (comes with MERLYN 90mm fast flow waste)				
Size	Tray Panel Kit (Order Separately)	Code	Price £ Exc. VAT	Price £ Inc. VAT
800	Kit 2	D80Q	241.89	290.27
900	Kit 2	D90Q	264.34	317.21
1000	Kit 5	D100Q	343.62	412.34

Tray Panel Kit (including Legs)				
	Kit 2	DRK2	131.96	158.35
	Kit 5	DRK5	131.96	158.35

Offset Quadrant Tray



Image shown as Left Handed (L) Please choose L for Left or R for Right when ordering.



Left Handed (L)



Right Handed (R)

Offset Quadrant Tray (comes with MERLYN 90mm fast flow waste)				
Size	Tray Panel Kit (Order Separately)	Code	Price £ Exc. VAT	Price £ Inc. VAT
900 X 760	Kit 1	D976Q L	353.65	424.39
900 X 760	Kit 1	D976Q R	353.65	424.39
1000 X 800	Kit 1	D108Q L	339.20	407.04
1000 X 800	Kit 1	D108Q R	339.20	407.04
1200 X 800	Kit 1	D128Q L	356.01	427.22
1200 X 800	Kit 1	D128Q R	356.01	427.22
1200 X 900	Kit 1	D129Q L	374.72	449.66
1200 X 900	Kit 1	D129Q R	374.72	449.66

Product Information

We have produced this product section to help you with your purchasing decision. For further information please contact your local stockist, details of which can be found at www.merlynshowering.com



Product information

All products are manufactured in accordance with EN14428 and utilise toughened safety glass to EN12150.

All shower trays are manufactured in accordance with EN14527.

All doors feature adjustable wall profiles to compensate for out-of-true walls and have micro adjustment features for fine tuning to obtain a perfect fit and operating action.

All enclosures, wetrooms and panels are Power Shower approved – will retain water under normal showering conditions.

Water retention is maintained in all products under normal showering conditions.

A selection of MERLYN enclosures are frameless in design. Spray/mist may escape therefore we would recommend use of these enclosures with tiled floors.

Opened cartons can not be returned. Returns carry a £40 box charge or £60 per unit where the sale is less than 30 days old. Returns over 30 days old will not be accepted.

All products are supplied complete with full installation instructions and the necessary fixings.

Check with your dealer for accurate matching of material samples. Product descriptions do not imply the use of precious or valuable materials.

Our policy of reviewing product design and development on a regular basis means MERLYN reserve the right to change product specifications and prices without notice.

Only shower enclosures, panels, MStone shower trays and bath screens are covered by the Lifetime Guarantee. Please contact the MERLYN sales team for more details.

Glass shattering and parts subject to wear are not covered by the Lifetime Guarantee.

For full details on all product ranges please contact MERLYN Showering on 0808 1011429 or log onto www.merlynshowering.com.

Trays shown in this catalogue are for illustrative purposes only.

Images are for illustration purposes only. The colours and finishes shown in the catalogue are as accurate as possible within the limits of the printing process. The positioning of all showering heads in the brochure is for illustrative purposes only.

All descriptions, specifications and particulars contained in this brochure are intended merely to represent a general idea of the products described herein and none of these form part of any contract to give rise to any independent or collateral liability upon the company.

Cleaning

- It is important to clean your MERLYN shower door and tray after every use. Wipe down all the glass and metal parts with a soft cloth.
- Do not allow lime scale to build up in hard water areas.
- Ensure that any residual water on the glass is removed after every use.

- Clean the glass regularly using soapy water.
- Do not use abrasive products on any surfaces.
- Install the enclosure in a well ventilated area.
- For more information on Mersfield Stayclear™ glass please see page 08 of this brochure.

Information and maintenance

Always read the instructions on the packaging, chrome is vulnerable to acid attack and some strong household cleaners including strong disinfectants, denture cleaners, hair dyes, wine making chemicals and photographic chemicals may contain acid. These materials may have a varying effect on the surface from black spots/streaks (which cannot be removed) to pitting the surface. Contact with these materials should be avoided.

Important shower tray information

- It is up to the designer or installer to ensure that the tray and enclosure combination is arranged in such a way that water retention meets the customers needs.
- The waste has the capacity to carry away 29L/Min. High powered systems may exceed this. Please check with the manufacturer.
- Please ensure that the shower head is not positioned directly over the waste as this may restrict water flow rate.
- Please ensure that the colour and size of shower tray You must inspect the product thoroughly before installation. Fitting the product is acceptance of quality.
- The trays are handmade from natural material. Please allow for height variances due to manufacturing tolerances.
- For open ended shower screens please consult your installer.
- Shower trays must be fitted as per the fitting instruction. Deviation from the pre installation checks or fitting installation will void the guarantee.
- When wet, the surface of the majority of shower trays will show an increase in the potential for slipping. This is particularly the case when soap, shampoo, bath oil etc. are used. It is important that designers, installers and users are aware of this.

Important

Although shower door and enclosure sizes are related to tray sizes it is important to note that most shower trays are tiled down to the rim, often over an 'up-stand'. The finished installation space may be less than the nominal tray size. MERLYN shower units are made to suit this remaining space.

Tray Finish min-max

The Tray Finish applies when fitting a door and a tray. These are the minimum and maximum dimensions that a shower door or enclosure will fit using standard wall profiles.

Tray finish

To find the correct Tray Finish dimension:

In a recess: Measure from the finished, tiled wall to the opposite finished, tiled wall.

In a corner: Measure from the finished, tiled wall to the edge of the tray.

Note: If the wall/walls are leaning in, this will further reduce your Tray Finish.

Adjustment

This is the min and max adjustment of the actual enclosure. These are the adjustment dimensions of the actual door excluding the tray. Therefore, these are the dimensions to follow when installing a enclosure in a wetroom application without a tray.

The guide below may be helpful in taking measurements to determine the shower door or enclosure size required. Dimensions given in this publication are in millimetres, are approximate and may vary with adjustment. They are subject to change without notice.

Please note that when a tray is fitted it is essential that the tray is level before any doors or enclosures are fitted.

Recess location

Take the measurements after the tray is installed and the walls are tiled.

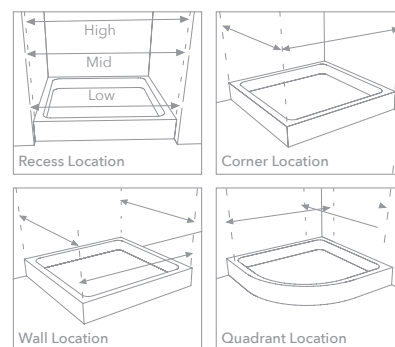

MERLYN revo

PRODUCT INFORMATION

Please read the complete instructions before commencing fitting.

This product must be installed by a qualified contractor. MERLYN does not accept responsibility for incorrectly installed products. Merlyn suggest for ease of use that the revo rail is installed at a height of approx 900mm from the floor/tray level. This may vary depending on the user's requirements.

Masonry wall installation

The rail product has been designed to withstand a vertical static load of 150KG. Exceeding this load may cause permanent damage. The fixings must be anchored into the below masonry wall types only

- Concrete ≥ C12/CSS
- Solid brick ≥ Mz12 (DIN 105)
- Sand-lime perforated brick ≥ KSL12(DIN 106)

Timber stud installation

When fixing into a timber stud no wall plug is used. The fixing must be anchored directly into a wooden stud or noggin with a depth no less than 60mm. Alterations to an existing stud frame may be necessary so that fixings are positioned directly into a stud or noggin.

Under no circumstances should this product be anchored through just tiles and tile adhesive with a backing of plasterboard, plywood, chipboard or similar.

DO NOT attempt to install the product unless you can tick all 5 boxes satisfactorily

- Check that you have the tools required
- Check the installation site is compatible with the rail supplied
- Check all rail components are present
- Check the installation kit is complete
- Check that your fixings are anchoring into a compatible wall type or directly into a timber stud/noggin with a depth no less than 60mm

CLEANING AND MAINTENANCE

It is important to clean your Merlyn revo rail after every use. Wipe down all parts with a soft cloth. Do not allow limescale to build up in hard water areas. Ensure that any residual water on the rail and container are removed after every use. If necessary the stainless steel base can be removed from the bottom of the container for ease of cleaning.

- Clean the components regularly using soapy water
- Do not use abrasive products on any surfaces
- Do not clean parts in a dishwasher

WARNING

The chrome and plastic components are vulnerable to

- hair dyes
- strong disinfectants
- strong household cleaners
- denture cleaners
- wine making or photographic chemicals

These may contain dyes, acid or abrasive chemicals which may have a varying effect on the surface from black spot/ streaks (which cannot be removed) to pitting the surface.

Contact with these materials should be avoided. If the container or other parts do encounter these dyes or chemicals please rinse thoroughly immediately after contact

Guarantee

MERLYN 15 year guarantee covers all metal parts on products used for Domestic purposes only. MERLYN guarantee all plastic and wearable parts against defect in materials for a period of 1 year from the date of purchase. The products must be installed and maintained in accordance with the instructions provided.

The guarantee does not cover:

- Non product faults such as damage caused by over loading of the accessory arm, improper use, inappropriate cleaning, lack of maintenance, build up of limescale, corrosion, chemical attack or where no fault has been found with the product
- Accidental or wilful damage
- Damage or defect caused by the repairing or modification by the user or installer

MERLYN™

Unit 8 Purcellsinch Industrial Estate, Dublin Road,
Kilkenny, Ireland, R95 HP71

T: 08081011429 / F: 08081011428

E: sales@merlyn.ie / technical@merlyn.ie

www.merlynshowering.com



MERLYN shower wiper

Introducing the MERLYN shower wiper to help you keep your enclosure sparkling for years to come. Includes a designer chrome branded holder to keep it within your reach.

Order Code	Price £ Exc. VAT	Price £ Inc. VAT
MG201WIPER	39.00	46.08



MERLYN glass shelf

Order Code	Price £ Exc. VAT	Price £ Inc. VAT
DWHSHELF	49.00	58.80

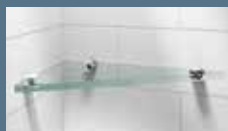

UKCA, CE & EN Information

The UKCA (UK Conformity Assessment) mark on MERLYN enclosures is the new standard marking for products on the market in Great Britain (England, Wales and Scotland). It is a declaration that the product complies with GB designated standards.

The CE markings on MERLYN enclosures is a declaration that the product complies with the essential requirements of the relevant European health, safety and environmental protection legislation.

EU and GB legislation requires manufacturers to display either the UKCA mark for Great Britain and a CE mark for the EU and Northern Ireland on their product or packaging. It is an offence to place a product on the relevant market without a UKCA for Great Britain or CE marking for the EU market. The UKCA marking came into effect on 1st January 2022.

The manufacturer is legally responsible for ensuring that the product conforms to the requirements of both directives. The European Commission thus refers to the CE marking as a "Passport" which allows products to be freely circulated

within the EU single market. The UKCA marking allows products to move freely within Great Britain.

Often consumers will consider the UKCA and CE markings on a product as an indication of conformance to laid down minimum standards and therefore, a minimum level of safety which other products may lack. Both markings are often seen by consumers as a "Symbol of Safety."



UKCA CE		 2 DOOR QUADRANT SHOWER ENCLOSURE
UK Distributor: Merlyn (a division of NGH), Ludfield House, Station Rd, Wilmslow, Cheshire, SK9 1BU.	Manufacturer: Merlyn Industries Limited, Unit 8 Purcellanch Ind. Estate, Killybeggy, Ireland, R55 HPY1.	
UKCA DOP: UKCATZ1.1 CE DOP: CESTZ1.1		HEIGHT 1850
Product Code here (MER19)		SIZE 800
PH		ADJUSTMENT 875/900
EN 14428		CLOUR CHROME
CA/IR/IDA		GLASS CLEAR
		CODE VGH439
		HEIGHT 476G
		PD 70804
		9005-0100

New GB, EU and NI label



MERLYN invests heavily in its product development and as such guarantees that its glass fully complies with regulations and is manufactured in accordance with BS EN 14428. The rigorous testing of the glass ensures that the endurance, stability and water retention criteria meet high industry standards.

ISO Certification

MERLYN has implemented an Integrated Management System comprising of Quality Management, Environmental Management and Occupational Health and Safety Management. An Integrated Management System ensures the seamless integration of several different standards

into a common system that meets the requirements of each of these standards. These certifications are proof of MERLYN's credibility but also to instil confidence in our potential clients that MERLYN will keep its promises.



Packaging guide

Please note from our packaging guide the number of boxes your door will be supplied in, depending on its size and model.

Side Panels are supplied in a separate, extra box. If the enclosure ordered is not listed in the guide, the product, installation guide and fixing kit are supplied in 1 box. Some products are handed, please state Right Hand (R) or Left Hand (L) when ordering.

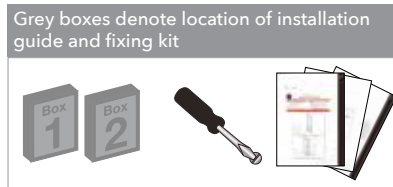

Please Note

Prices were correct at time of print April 2023. V.A.T. at the rate of 20%. E&OE. Due to circumstances beyond our control, prices may be altered including changes to the rate of V.A.T.

Due to our policy of continuous improvement, we reserve the right to amend prices, specifications and designs without prior notice. Images are for illustrated purposes only. The colours and finishes shown in the catalogue are as accurate as possible within the limits of the printing process. All descriptions, specifications and particulars contained in this brochure are intended merely to represent a general idea of the products described herein and none of these form part of any contract to give rise to any independent or collateral liability upon the company.

10 Series

Sliding Door



Fixed Flat Panel
Moving Panel (Door) Left or Right

10 Series

Pivot Door & Inline Panel



Pivot Door
Inline Panel

10 Series

1 Door Offset Quadrant



Curved Moving Panel
Fixed Flat Panel
Panel Left or Right

10 Series

One Door Quadrant



Curved Moving Panel
Fixed Flat Panel
Left or Right

8 Series Frameless

Hinge & Inline



Fixed Panel Left or Right
Moving Panel (Door)
***900 Hinge and Inline is supplied in one box**

8 Series Frameless

One Door Quadrant



Moving Panel (Door), Hinged
Fixed Panel
Magnetic Fixed Panel

8 Series Frameless

1 Door Offset Quadrant



Moving Panel (Door), Hinged
Fixed Panel
Magnetic Fixed Panel

8 Series Frameless

Sliding Door



Fixed Panel
Moving Panel (Door)

8 Series

One Door Quadrant



Fixed Panel
Moving Panel (Door)

8 Series

Two Door Quadrant



Fixed Panel
Moving Panel (Door)

8 Series

1 Door Offset Quadrant



Fixed Panel
Moving Panel (Door)

8 Series

Sliding Door



Fixed Panel
Moving Panel (Door)
***1000, 1100 & 1200 are packaged in one box**

8 Series

Infold Door & Inline Panel



Fixed Panel
Moving Panel (Door)

8 Series

Walk In



Curved Fixed Panel,
Straight Fixed Panel

6 Series

1 Door Offset Quadrant



Curved Fixed Panel, Straight
Fixed Panel

6 Series Frameless

Hinge & Inline



Fixed Panel
Moving Panel with hardware

6 Series enclosures come in 1 box, with the exception of the 1 Door Offset Quadrant as noted and Sliding Doors of 1400mm or more.

Tray Waste Positions

TrueStone Trays



Rectangular Tray

Size	Waste Position (A)	Waste Position (B)
1000 x 800	200	400
1200 x 800	250	400
1200 x 900	250	450
1400 x 800	350	400
1400 x 900	350	450
1500 x 800	400	400
1500 x 900	400	450
1600 x 800	450	400
1600 x 900	450	450
1700 x 800	500	400
1700 x 900	500	450

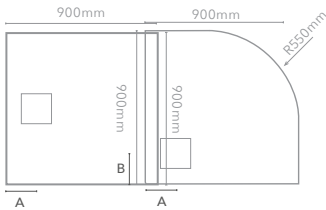

Square Tray

Size	Waste Position (A)	Waste Position (B)
900 x 900	270	450

Quadrant Tray

Size	Waste Position (A)	Waste Position (B)
900 x 900	270	270

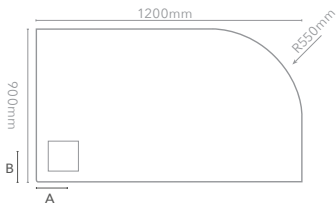

Offset Quadrant Tray

Size	Waste Position (A)	Waste Position (B)
1200 x 900	270	270

Please Note: For all trays, waste dimensions are to the centre of waste.

Level 25 Trays

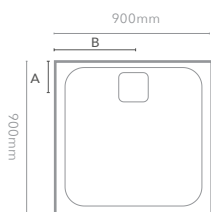

Square Tray

Size	Waste Position (A)	Waste Position (B)
900 x 900	121.5	450

Level 25 Trays

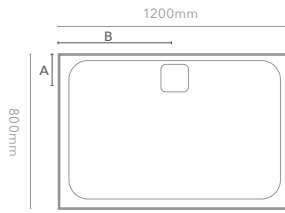

Rectangular Tray

Size	Waste Position (A)	Waste Position (B)
1000 x 800	121.5	500
1000 x 900	121.5	500
1100 x 800	121.5	550
1100 x 900	121.5	550
1200 x 800	121.5	600
1200 x 900	121.5	600
1300 x 800	121.5	650
1300 x 900	121.5	650
1400 x 800	121.5	700
1400 x 900	121.5	700
1500 x 800	121.5	750
1500 x 900	121.5	750
1600 x 800	121.5	800
1600 x 900	121.5	800
1700 x 800	121.5	850
1700 x 900	121.5	850

Quadrant Tray

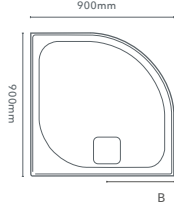

Offset Quadrant Tray

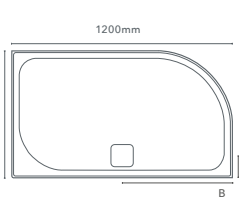

Quadrant Trays

Size	Waste Position (A)	Waste Position (B)
900 x 900	121.5	450
1200 x 900	121.5	600

MStone Trays

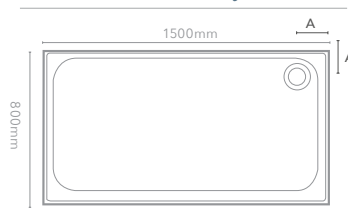

Rectangular Tray

Size	Waste Position (A)	Waste Position (B)
900 x 760	147	
1000 x 800	147	
1100 x 760	147	
1100 x 800	147	
1200 x 700	147	
1200 x 760	147	
1200 x 800	147	
1200 x 900	147	
1400 x 800	147	
1400 x 900	147	
1500 x 700	147	
1500 x 800	147	
1500 x 900	147	
1600 x 800	147	
1600 x 900	147	
1685 x 700	147	
1680 x 760	147	

MStone Trays Continued...

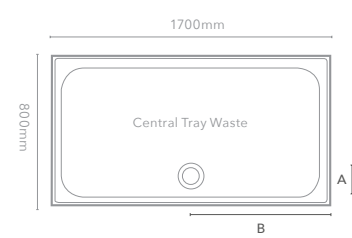

Rectangular Tray

Size	Waste Position (A)	Waste Position (B)
1700 x 800	130	850

Waste is centred for 1700 x 800 tray - D178RT

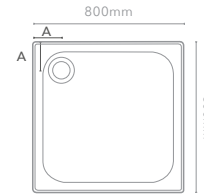

Square Tray

Size	Waste Position (A)	Waste Position (B)
760	147	
800	147	
900	147	

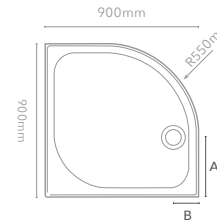

Quadrant Tray

Size	Waste Position (A)	Waste Position (B)
800	250	130
900	350	130
1000	350	130

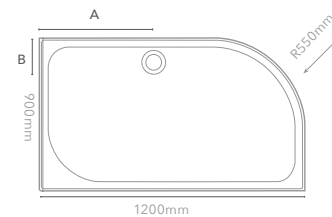

Offset Quadrant Tray

Size	Waste Position (A)	Waste Position (B)
900 x 760 L	250	130
900 x 760 R	250	130
1000 x 800 L	350	130
1000 x 800 R	350	130
1200 x 800 L	450	130
1200 x 800 R	450	130
1200 x 900 L	450	130
1200 x 900 R	450	130
1400 x 800 L	510	300
1400 x 800 R	510	300

DISCLAIMER

Please ensure that the shower head is not positioned directly over the waste as this may restrict flow rate.

Extension Profiles

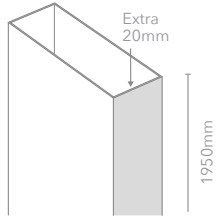

10 Series Sliding Door

Code	Height	Price £ Exc. VAT	Price £ Inc. VAT
M108EXTSL	1950	118.52	142.22

Series 10 extension profile: extra 20mm.
Sliding Door can only be used with one extension profile.

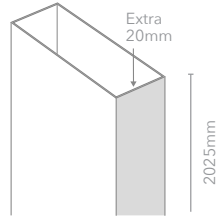

10 Series Pivot - Hinged Side

Code	Height	Price £ Exc. VAT	Price £ Inc. VAT
M108ETPVH	2025	118.52	142.22

Series 10 extension profile: extra 20mm.
Series 10 Pivot Hinge Side extension to be fitted on the same side as the door hinge.

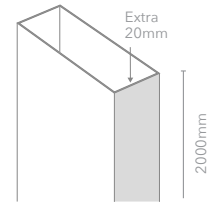

10 Series Pivot - Closing Side

Code	Height	Price £ Exc. VAT	Price £ Inc. VAT
M108ETPV	2000	118.52	142.22

Series 10 extension profile: extra 20mm.
Series 10 Pivot Side Panel extension to be fitted on the closing post, Inline Panel or Side Panel side.

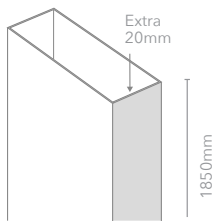

10 Series Quadrant

Code	Height	Price £ Exc. VAT	Price £ Inc. VAT
M108EXTQU	1850	118.52	142.22

Series 10 extension profile: extra 20mm

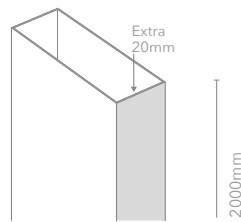

8 Series Frameless - Hinge and Quadrant Doors

Code	Height	Price £ Exc. VAT	Price £ Inc. VAT
A0614A0	2000	97.60	117.12

8 Series Frameless extension profile: extra 20mm.

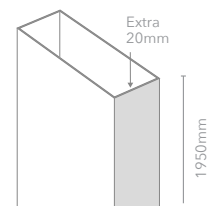

8 Series Frameless - Hinged Bifold Door

Code	Height	Price £ Exc. VAT	Price £ Inc. VAT
M8FBEXT20	1950	91.57	109.89

8 Series Frameless extension profile: extra 20mm.

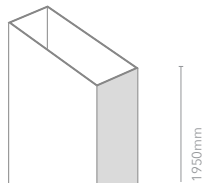

8 Series Frameless - Pivot / Pivot & Inline

Code	Height	Price £ Exc. VAT	Price £ Inc. VAT
M8FBEXT20	1950	91.57	109.89

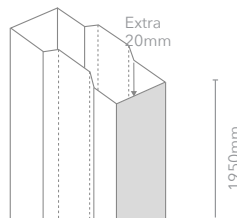

8 Series

Code	Height	Price £ Exc. VAT	Price £ Inc. VAT
M8EXT20	1950	89.63	107.56

8 Series extension profile: extra 20mm.

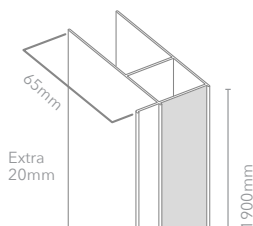

6 Series

Code	Height	Price £ Exc. VAT	Price £ Inc. VAT
M6EXT	1900	82.50	99.00

Series 6 extension profile: extra 20mm.
No extension profile available for: wetroom panels.

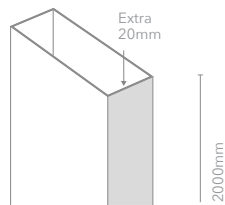

6 Series Frameless

Code	Height	Price £ Exc. VAT	Price £ Inc. VAT
S6FEXT	2000	93.81	112.57

6 Series Frameless extension profile: extra 20mm.

6 | series

Inline Panel - Space Solutions

Our 6 Series range includes the option of additional Inline Panels to ensure the 6 Series can be used in any space from 670mm to 1915mm. Simply choose the adjustment for your space and we will create the ideal combination for you.

Inline Panels

6 Series Inline Panels			
Adjustment / Wetroom Min-Max	Code	Price £ Exc. VAT	Price £ Inc. VAT
140	M6I125	346.57	415.89
215	M6I200	363.97	436.76

Sliding Door - and Inline panel

Sliding Door					
Size	Size of Door Supplied	Code	Inline Panel Supplied	Price £ Exc. VAT	Price £ Inc. VAT
950-1000	1000	M68231	-	776.01	931.22
1050-1100	1100	M68251	-	776.01	931.22
1065-1140	1000	M68231P1H	140	1299.08	1558.89
1140-1215	1000	M68231P2H	215	1316.48	1579.78
1150-1200	1200	M68241	-	776.01	931.22
1165-1240	1100	M68251P1H	140	1122.58	1347.09
1240-1315	1100	M68251P2H	215	1139.98	1367.98
1265-1340	1200	M68241P1H	140	1122.58	1347.09
1340-1415	1200	M68241P2H	215	1139.98	1367.98
1350-1400	1400	M68291	-	1299.08	1558.89
1360-1460	1100	M68251PPH	140+215	1486.55	1783.86
1450-1500	1500	M68261	-	1014.45	1217.34
1465-1540	1400	M68291P1H	140	1361.01	1633.22
1540-1615	1400	M68291P2H	215	1316.48	1579.78
1550-1600	1600	M68271	-	1071.75	1286.10
1565-1640	1500	M68261P1H	140	1361.01	1633.22
1640-1715	1500	M68261P2H	215	1378.43	1654.11
1650-1700	1700	M68281	-	1071.75	1286.10
1665-1740	1600	M68271P1H	140	1418.31	1701.97
1740-1815	1600	M68271P2H	215	1435.74	1722.89
1765-1840	1700	M68281P1H	140	1418.31	1701.97
1840-1915	1700	M68281P2H	215	1435.74	1722.89

Please add 20mm to size when using with a Side Panel.
Optional Side Panel available: [See Page 58.](#)

Pivot Door - and Inline panel

Pivot Door					
Size	Size of Door Supplied	Code	Inline Panel Supplied	Price £ Exc. VAT	Price £ Inc. VAT
670-720	700	M61201 N	-	559.01	670.82
690-740	700	M61201H	EXT	641.52	769.83
740-790	760/800	M61211 N	-	629.37	755.25
785-860	700	M61201P1H	140	905.59	1086.70
850-900	900	M61221 N	-	659.79	791.75
860-935	700	M61211P1H	215	923.00	1107.60
930-1005	760/800	M61211P2H	215	993.34	1192.01
950-1000	1000	M61231 N	-	695.50	834.60
965-1040	900	M61221P1H	140	1006.38	1207.65
1040-1115	900	M61221P2H	215	1023.78	1228.54
1065-1140	1000	M61231P1H	140	1042.05	1250.46
1140-1215	1000	M61231P2H	215	1059.45	1271.34

Please add 20mm to size when using a Side Panel
Optional Side Panel available: [See page 59.](#)

Bifold Door - and Inline panel

Sliding Door					
Size	Size of Door Supplied	Code	Inline Panel Supplied	Price £ Exc. VAT	Price £ Inc. VAT
670-720	700	M67201 N	-	867.91	1041.49
690-740	700	M67201H	EXT	950.43	1140.52
740-790	760/800	M67211 N	-	867.91	1041.49
785-860	700	M67201PH	140	1214.48	1457.38
850-900	900	M67221 N	-	930.28	1116.34
860-935	700	M67201P2H	215	1231.90	1478.28
930-1005	760/800	M67211P2H	215	1231.90	1478.28
950-1000	1000	M67231 N	-	978.41	1174.09
965-1040	900	M67221P1H	140	1276.84	1532.21
1040-1115	900	M67221P2H	215	1294.25	1553.10
1065-1140	1000	M67231P1H	140	1324.97	1589.97
1140-1215	1000	M67231P2H	215	1342.38	1610.85

Please add 20mm to size when using with a Side Panel.
Optional Side Panel available: [See Page 60.](#)

Inline Panel - Space Solutions

Our 8 Series range includes the option of additional Inline Panels to ensure the 8 Series can be used in any space from 650mm to 1900mm. Simply choose the adjustment for your space and we will create the ideal combination for you.

Inline Panels

8 Series Inline Panels			
Adjustment / Wetroom Min-Max	Code*	Price £ Exc. VAT	Price £ Inc. VAT
150	M8P140	365.50	438.60
210	M8P2200	382.72	459.26

Infold Door

- and Inline Panel

Sliding Door					
Size	Size of Door Supplied	Code	Inline Panel Supplied	Price £ Exc. VAT	Price £ Inc. VAT
650-690	700	M84401	-	1052.87	1263.44
670-710	700	M84401H	EXT.	1142.50	1371.00
710-750	760	M84410	-	1070.43	1284.51
750-790	800	M84411	-	1091.45	1309.74
780-840	700	M84401P1H	150	1418.35	1702.01
840-900	700	M84401P2H	210	1435.57	1722.69
850-890	900	M84421	-	1107.06	1328.48
900-960	760	M84410P1H	210	1453.13	1743.76
950-990	1000	M84431	-	1496.77	1796.12
940-1000	800	M84411P2H	210	1474.17	1769.00
980-1040	900	M84421P1H	150	1472.56	1767.08
1040-1100	900	M84421P2H	210	1489.79	1787.75
1080-1140	1000	M84431P1H	150	1570.53	1884.64
1140-1200	1000	M84431P2H	210	1587.75	1905.29

Please add 20mm to size when using with a Side Panel.

Optional Side Panel available: [See Page 46.](#)

Hinge Door

- and Inline Panel

Sliding Door					
Size	Size of Door Supplied	Code	Inline Panel Supplied	Price £ Exc. VAT	Price £ Inc. VAT
650-690	700	M81201	-	993.87	1192.64
670-710	700	M81201H	EXT.	1083.51	1300.21
710-750	760	M81210	-	1376.59	1651.91
750-790	800	M81211	-	1378.57	1654.29
780-840	700	M81201PH	150	1142.50	1371.00
840-900	700	M81210P1H	210	1376.59	1651.91
850-890	900	M81221	-	1468.00	1761.59
900-960	760	M81210P2H	210	1378.57	1654.29
950-990	1000	M81231	-	1532.73	1839.28
940-1000	800	M81211PH	210	1378.57	1654.29
980-1040	900	M81221P1H	150	1468.00	1761.59
1040-1100	900	M81221P2H	210	1485.21	1782.25
1080-1140	1000	M81231P1H	150	1532.73	1839.28
1140-1200	1000	M81231P2H	210	1549.95	1859.93

Please add 20mm to size when using with a Side Panel.

Optional Side Panel available: [See Page 34.](#)

Sliding Door

- and Inline Panel

Sliding Door					
Size	Size of Door Supplied	Code	Inline Panel Supplied	Price £ Exc. VAT	Price £ Inc. VAT
950-990	1000	M88231	-	1087.95	1305.53
1050-1090	1100	M88251	-	1087.95	1305.53
1080-1140	1000	M88231P1H	150	1453.46	1744.15
1140-1200	1000	M88231P2H	210	1470.67	1764.81
1150-1190	1200	M88241	-	1087.95	1305.53
1180-1240	1100	M88251P1H	150	1453.46	1744.15
1240-1300	1100	M88251P2H	210	1470.67	1764.81
1280-1340	1200	M88241P1H	150	1453.46	1744.15
1340-1400	1200	M88241P2H	210	1470.67	1764.81
1250-1290	1300	M88240	-	1322.51	1587.01
1350-1390	1400	M88291	-	1375.37	1650.45
1370-1450	1100	M88251H	150+210	1836.17	2203.41
1450-1490	1500	M88261	-	1423.13	1707.75
1480-1540	1400	M88291P1H	150	1740.86	2089.03
1540-1600	1400	M88291P2H	210	1758.08	2109.69
1550-1590	1600	M88271	-	1440.68	1728.81
1580-1640	1500	M88261P1H	150	1788.64	2146.37
1640-1700	1500	M88261P2H	210	1805.85	2167.03
1650-1690	1700	M88281	-	1510.87	1813.04
1680-1740	1600	M88271P1H	150	1806.16	2167.39
1740-1800	1600	M88271P2H	210	1823.39	2188.07
1780-1840	1700	M88281P1H	150	1876.37	2251.64
1840-1900	1700	M88281P2H	210	1893.58	2272.30

Please add 20mm to size when using with a Side Panel.

Optional Side Panel available: [See Page 42.](#)

MERLYN™

Unit 8, Purcellsinch Industrial Estate, Dublin Road, Kilkenny, Ireland, R95 HP71.

T:0808 1011 429 / F:0808 1011 428

E: sales@merlyn.ie / technical@merlyn.ie

www.merlynshowering.com



MERLYN™ series

